

Pioneer

DVD PLAYER

DV-C302D

Operating Instructions



Please read through these operating instructions so you will know how to operate your model properly. After you have finished reading the instructions, put them away in a safe place for future reference.

- This player is not suitable for commercial use.

IMPORTANT



The lightning flash with arrowhead symbol, within an equilateral triangle, is intended to alert the user to the presence of uninsulated "dangerous voltage" within the product's enclosure that may be of sufficient magnitude to constitute a risk of electric shock to persons.



CAUTION:
TO PREVENT THE RISK OF ELECTRIC SHOCK, DO NOT REMOVE COVER (OR BACK). NO USER-SERVICEABLE PARTS INSIDE. REFER SERVICING TO QUALIFIED SERVICE PERSONNEL.



The exclamation point within an equilateral triangle is intended to alert the user to the presence of important operating and maintenance (servicing) instructions in the literature accompanying the appliance.

IMPORTANT SAFETY INSTRUCTIONS

READ INSTRUCTIONS — All the safety and operating instructions should be read before the product is operated.

RETAIN INSTRUCTIONS — The safety and operating instructions should be retained for future reference.

HEED WARNINGS — All warnings on the product and in the operating instructions should be adhered to.

FOLLOW INSTRUCTIONS — All operating and use instructions should be followed.

CLEANING — Unplug this product from the wall outlet before cleaning. The product should be cleaned only with a polishing cloth or a soft dry cloth. Never clean with furniture wax, benzene, insecticides or other volatile liquids since they may corrode the cabinet.

ATTACHMENTS — Do not use attachments not recommended by the product manufacturer as they may cause hazards.

WATER AND MOISTURE — Do not use this product near water — for example, near a bathtub, wash bowl, kitchen sink, or laundry tub; in a wet basement; or near a swimming pool; and the like.

ACCESSORIES — Do not place this product on an unstable cart, stand, tripod, bracket, or table. The product may fall, causing serious injury to a child or adult, and serious damage to the product. Use only with a cart, stand, tripod, bracket, or table recommended by the manufacturer, or sold with the product. Any mounting of the product should follow the manufacturer's instructions, and should use a mounting accessory recommended by the manufacturer.

CART — A product and cart combination should be moved with care. Quick stops, excessive force, and uneven surfaces may cause the product and cart combination to overturn.



VENTILATION — Slots and openings in the cabinet are provided for ventilation and to ensure reliable operation of the product and to protect it from overheating, and these openings must not be blocked or covered. The openings should never be blocked by placing the product on a bed, sofa, rug, or other similar surface. This product should not be placed in a built-in installation such as a bookcase or rack unless proper ventilation is provided or the manufacturer's instructions have been adhered to.

POWER SOURCES — This product should be operated only from the type of power source indicated on the marking label. If you are not sure of the type of power supply to your home, consult your product dealer or local power company.

LOCATION — The appliance should be installed in a stable location.

NONUSE PERIODS — The power cord of the appliance should be unplugged from the outlet when left unused for a long period of time.

GROUNDING OR POLARIZATION

- If this product is equipped with a polarized alternating current line plug (a plug having one blade wider than the other), it will fit into the outlet only one way. This is a safety feature. If you are unable to insert the plug fully into the outlet, try reversing the plug. If the plug should still fail to fit, contact your electrician to replace your obsolete outlet. Do not defeat the safety purpose of the polarized plug.
- If this product is equipped with a three-wire grounding type plug, a plug having a third (grounding) pin, it will only fit into a grounding type power outlet. This is a safety feature. If you are unable to insert the plug into the outlet, contact your electrician to replace your obsolete outlet. Do not defeat the safety purpose of the grounding type plug.

POWER-CORD PROTECTION — Power-supply cords should be routed so that they are not likely to be walked on or pinched by items placed upon or against them, paying particular attention to cords at plugs, convenience receptacles, and the point where they exit from the product.

OUTDOOR ANTENNA GROUNDING — If an outside antenna or cable system is connected to the product, be sure the antenna or cable system is grounded so as to provide some protection against voltage surges and built-up static charges. Article 810 of the National Electrical Code, ANSI/NFPA 70, provides information with regard to proper grounding of the mast and supporting structure, grounding of the lead-in wire to an antenna discharge unit, size of grounding conductors, location of antenna-discharge unit, connection to grounding electrodes, and requirements for the grounding electrode. See Figure A.

LIGHTNING — For added protection for this product during a lightning storm, or when it is left unattended and unused for long periods of time, unplug it from the wall outlet and disconnect the antenna or cable system. This will prevent damage to the product due to lightning and power-line surges.

POWER LINES — An outside antenna system should not be located in the vicinity of overhead power lines or other electric light or power circuits, or where it can fall into such power lines or circuits. When installing an outside antenna system, extreme care should be taken to keep from touching such power lines or circuits as contact with them might be fatal.

OVERLOADING — Do not overload wall outlets, extension cords, or integral convenience receptacles as this can result in a risk of fire or electric shock.

OBJECT AND LIQUID ENTRY — Never push objects of any kind into this product through openings as they may touch dangerous voltage points or short-out parts that could result in a fire or electric shock. Never spill liquid of any kind on the product.

SERVICING — Do not attempt to service this product yourself as opening or removing covers may expose you to dangerous voltage or other hazards. Refer all servicing to qualified service personnel.

DAMAGE REQUIRING SERVICE — Unplug this product from the wall outlet and refer servicing to qualified service personnel under the following conditions:

- When the power-supply cord or plug is damaged.
- If liquid has been spilled, or objects have fallen into the product.
- If the product has been exposed to rain or water.
- If the product does not operate normally by following the operating instructions. Adjust only those controls that are covered by the operating instructions as an improper adjustment of other controls may result in damage and will often require extensive work by a qualified technician to restore the product to its normal operation.
- If the product has been dropped or damaged in any way.
- When the product exhibits a distinct change in performance — this indicates a need for service.

REPLACEMENT PARTS — When replacement parts are required, be sure the service technician has used replacement parts specified by the manufacturer or have the same characteristics as the original part. Unauthorized substitutions may result in fire, electric shock, or other hazards.

SAFETY CHECK — Upon completion of any service or repairs to this product, ask the service technician to perform safety checks to determine that the product is in proper operating condition.

WALL OR CEILING MOUNTING — The product should not be mounted to a wall or ceiling.

HEAT — The product should be situated away from heat sources such as radiators, heat registers, stoves, or other products (including amplifiers) that produce heat.

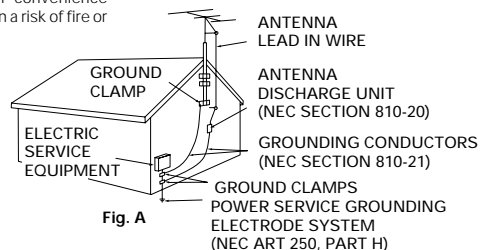

Fig. A

CONGRATULATIONS ON YOUR PURCHASE OF THIS FINE PIONEER PRODUCT.

Pioneer is on the leading edge of DVD research for consumer products and this unit incorporates the latest technological developments.

We are sure you will be fully satisfied with the DVD player.

Thank you for your support.

WARNING: TO PREVENT FIRE OR SHOCK HAZARD, DO NOT EXPOSE THIS APPLIANCE TO RAIN OR MOISTURE.

IMPORTANT NOTICE

[For U.S. and Canadian models]

The serial number for this equipment is located on the rear panel. Please write this serial number on your enclosed warranty card and keep it in a secure area. This is for your security.

CAUTION: This product satisfies FCC regulations when shielded cables and connectors are used to connect the unit to other equipment. To prevent electromagnetic interference with electric appliances such as radios and televisions, use shielded cables and connectors for connections.

This equipment has been tested and found to comply with the limits for a Class B digital device, pursuant to Part 15 of the FCC Rules. These limits are designed to provide reasonable protection against harmful interference in a residential installation. This equipment generates, uses, and can radiate radio frequency energy and, if not installed and used in accordance with the instructions, may cause harmful interference to radio communications. However, there is no guarantee that interference will not occur in a particular installation. If this equipment does cause harmful interference to radio or television reception, which can be determined by turning the equipment off and on, the user is encouraged to try to correct the interference by one or more of the following measures:

- Reorient or relocate the receiving antenna.
- Increase the separation between the equipment and receiver.
- Connect the equipment into an outlet on a circuit different from that to which the receiver is connected.
- Consult the dealer or an experienced radio/TV technician for help.

Information to User

Alteration or modifications carried out without appropriate authorization may invalidate the user's right to operate the equipment.

CAUTION

- Use of controls or adjustments or performance of procedures other than those specified herein may result in hazardous radiation exposure.
- The use of optical instruments with this product will increase eye hazard.

[For Canadian model]

This Class B digital apparatus complies with Canadian ICES-003.

[Pour le modèle Canadien]

Cet appareil numérique de la classe B est conforme à la norme NMB-003 du Canada.

THE POWER SWITCH IS SECONDARY CONNECTED AND THEREFORE DOES NOT SEPARATE THE UNIT FROM MAINS POWER IN THE STANDBY POSITION.

[For Canadian model]



CAUTION: TO PREVENT ELECTRIC SHOCK, DO NOT USE THIS (POLARIZED) PLUG WITH AN EXTENSION CORD, RECEPTACLE OR OTHER OUTLET UNLESS THE BLADES CAN BE FULLY INSERTED TO PREVENT BLADE EXPOSURE.

ATTENTION: POUR PREVENIR LES CHOCS ELECTRIQUES NE PAS UTILISER CETTE FICHE POLARISEE AVEC UN PROLONGATEUR, UNE PRISE DE COURANT OU UNE AUTRE SORTIE DE COURANT, SAUF SI LES LAMES PEUVENT ETRE INSEREES A FOND SANS EN LAISSER AUCUNE PARTIE A DECOUVERT.

Features of This Player

Compatible with DVD, Video CD and CD formats

DVD, Video CD and CD discs that display the logos shown below can be played back on PIONEER DVD players. For more information on discs compatible with this player, refer to the table below.

Types of playable discs and their marks	Diameter/ Playable sides	Playback time
	DVD VIDEO	Digital audio Digital video (MPEG 2)
	12 cm (5 in.)/ single-sided	1 layer 2 layer 133 min. 242 min.
	12 cm (5 in.)/ double-sided	1 layer 2 layer 266 min. 484 min.
	DVD VIDEO*	Digital audio Digital video (MPEG 2)
	8 cm (3 in.)/ single-sided	1 layer 2 layer 41 min. 75 min.
	8 cm (3 in.)/ double-sided	1 layer 2 layer 82 min. 150 min.
	VIDEO CD	Digital audio Digital video (MPEG 1) Max. 74 minutes
	12 cm (5 in.)/ single-sided	
	VIDEO CD single	Digital audio Digital video (MPEG 1) Max. 20 minutes
	8 cm (3 in.)/ single-sided	
	CD	Digital audio
	12 cm (5 in.)/ single-sided	Max. 74 minutes
	CD single	Digital audio
	8 cm (3 in.)/ single-sided	Max. 20 minutes

The disc format logos shown above are found on disc labels or on disc jackets.

- To prevent malfunction, do not use an 8 cm (3 in.) adaptor (for CDs).
- Discs other than the ones indicated above cannot be played on this unit.
- DVDs that have incompatible region numbers, DVD-Audio, DVD-ROM, and CD-ROM cannot be played on this unit. The region number of the player can be found on the rear panel.

State of the art digital audio and video



Compatible with a wide range of digital audio output formats

DVDs are recorded in one of four types of digital audio formats. The digital audio output jacks of this player can output Dolby Digital*, DTS**, MPEG, and linear PCM digital bitstreams to AV components with built in decoding capabilities.

This player also has a function that converts Dolby Digital and MPEG audio formats into the linear PCM format. This allows stereo playback of DVDs recorded in Dolby Digital and MPEG without the need for a special decoder.

Equipped with six channel discrete audio output and an internal Dolby Digital decoder

Enjoy the cinematic surround sound produced by Dolby Digital audio soundtracks without the need for an external decoder. This player features six channel discrete audio output jacks so you can connect this player directly to an amplifier or receiver with 6 channel discrete input, and utilize the player's built-in Dolby Digital decoding capabilities.

You can enjoy the unique operation of a 3-disc changer.

A disc that is currently playing can be easily exchanged with two other discs. In addition, you can play your favorite disc with the press of a button.

* Manufactured under license from Dolby Laboratories. "Dolby" and the double-D symbol are trademarks of Dolby Laboratories. Confidential Unpublished Works, © 1992-1997 Dolby Laboratories. All rights reserved.

** "DTS" and "DTS Digital" are trademarks of Digital Theater Systems, Inc.

Easy setup and adjustment using on-screen menus

Press **SETUP** on the remote control to open the Setup screen and you'll find setting up and adjusting the system easy to do with on-screen menus conveniently organized and arranged. Additionally, on-screen information (i) appears to clarify the functions and explain the options available. Below are just a few examples.

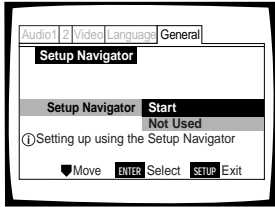

Answer a few questions and have all the necessary audio, video, and on-screen language adjustments set automatically by the player using the Setup Navigator (page 20).

Set up the on-screen speaker system to match your home audio system in the **Audio 2** menu for ideal presentation of multichannel audio (page 32).

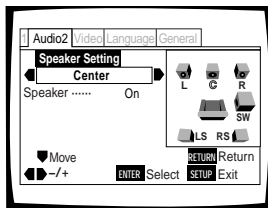

Wide range of DVD viewing options

Multi-Language Subtitles (page 35)★

You can select a subtitle language or turn subtitles off when watching movies or other media with subtitles available.

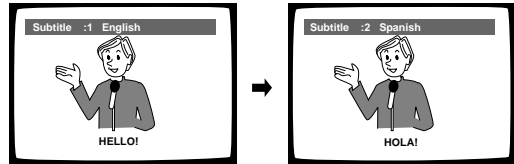

Multiple Languages (page 36)★

You can select the language on when watching movies or other media that have multiple language and/or audio soundtracks recorded on them.

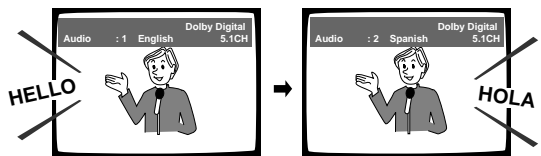

Multi-Angle (page 43)★

You can view scenes from different camera angles when watching movies or other media with multiple angle playback available.

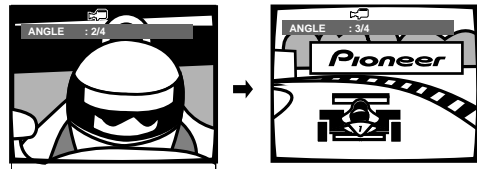

★This mark indicates this may not be possible with certain discs.

Energy-saving design

This unit is designed to use minimal electricity when this player is in standby mode. Regarding the amount of power consumed in standby mode, refer to 'Specifications' on page 62.

This product incorporates copyright protection technology that is protected by method claims of certain U. S. patents and other intellectual property rights owned by Macrovision Corporation and other rights owners. Use of this copyright protection technology must be authorized by Macrovision Corporation, and is intended for home and other limited viewing uses only unless otherwise authorized by Macrovision Corporation. Reverse engineering or disassembly is prohibited.

Differences in Disc Composition

DVD

DVDs are divided into units referred to as titles, and titles are divided into chapters. A DVD which contains a movie may have only one title with many or no chapter divisions. Karaoke DVDs may have many titles, assigning a title to each song on the DVD. Menu screens do not belong to any title.

DVD player functions generally apply to titles on a DVD or chapters within a selected title. The player functions available may also vary from title to title, depending on the DVD. When DVDs have a unique title division, it should be noted that search and program functions may be affected.

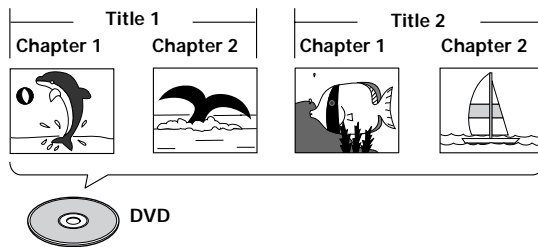

Video CD/CD

Video CDs and CDs are divided into units referred to as tracks (Video CD tracks may also be referred to as scenes). One song generally corresponds to one track. Some tracks are further divided into units referred to as indexes. Video CDs with PBC (Playback Control) also contain menus recorded on the disc which enable easy access to the contents of the disc.

When played back on a DVD player, both Video CDs and CDs are considered to be a single title, regardless of the number of tracks.

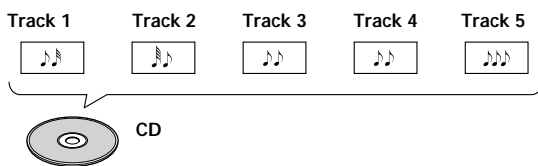
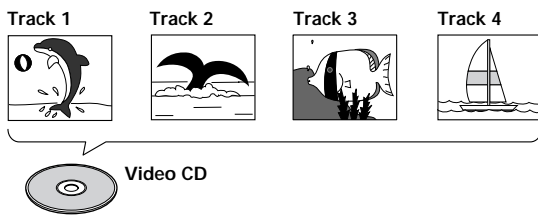

How to Proceed in This Manual

DVD is an incredible format that presents the highest quality digital audio and video available today. Because using the DVD player and DVDs may be confusing at first, following the order below should help you get through the important stages of getting set up so you can start using your player as soon as possible.

Get familiar with the player.

Refer to the section "Before Using" on page 8 to confirm that all the accessories were included with the player. If you are new to DVD, it might be beneficial for you to go through the "Names and Functions" section starting on page 9 to get familiar with the parts and buttons on the main unit and remote control as they will be referred to throughout this manual.

There is also a list of terms that can be found on page 60 if you are having trouble understanding some of the terminology associated with DVD.

Make the necessary connections.

No entertainment system seems to be set up exactly the same way. The "Making Connections" section starting on page 15 shows how video and audio connections may be made to suit your home entertainment system.

Set up the player.

Before you can begin to enjoy the benefits of the DVD format, it is first necessary to set up the player to output the video and audio information that corresponds to your system. The section "Setting Up the Player" starting on page 20 explains how to use the Setup Navigator, a function that automatically sets up the player corresponding to the answers given in a multiple-choice on-screen procedure. The Setup screen menus, described in the section starting on page 28, are also used in a number of other functions. Learning the procedure for operating these menus will make using this player much easier and more enjoyable.

Play a disc.

When all the connections and setups have been made, you are ready to play a DVD, Video CD, or CD with the player. The section "Getting Started Using Your DVD Player" starting on page 24 outlines the basic player operations.

Enjoy the many features available.

Once you are comfortable using the basic player functions, you are ready to take advantage of the various options DVD and this player have to offer. The section "Advanced Functions" starting on page 40 describes how to use the features available on many DVDs.

Table of Contents

Before Using	8	Setting the Language Options	35
Checking Accessories	8	Selecting a Subtitle Language (Multi-Language Subtitles)	35
Preparing the Remote Control	8	Changing the Audio Language (Multi-Language Function)	36
Names and Functions	9	Setting Language and Subtitle Preferences in the Setup Screen Menus	37
Front Panel	9	Advanced Functions	40
Display Window	11	Adjusting the Dynamic Range of the Audio Soundtrack	40
Rear Panel	12	Selecting Picture Quality Appropriate for Program Content	40
Remote Control	13	Still Frame/Slow Play/Frame Advance Playback	41
Making Connections	15	Searching for a Title, Chapter, Track, or Location on a Disc	42
Connecting Your DVD Player	15	Viewing from a Desired Camera Angle (Multi-Angle)	43
Audio Connections	17	Repeat Play	44
Video Connections	19	Random Play	45
System Control Connections	19	Playback in a Desired Order (Program Play)	46
Setting Up the Player	20	Setting the Parental Lock Level	48
Using the Setup Navigator	20	Continuing Playback from a Specified Location (Last Memory)	50
Getting Started Using Your DVD Player	24	Memorizing Settings for Often Viewed DVDs (Condition Memory)	51
Playing DVDs, Video CDs and CDs	24	Viewing Disc Information	52
Chapter (Track) Skip Forward/Skip Back	26	Changing the Background Color of the Screen	54
Forward and Reverse Scanning	26	Turning the Screen Saver On and Off	54
Stopping Playback and Switching Power Off	27	Resetting the Player to System Settings	54
Adjusting Audio and Video Settings	28	Additional Information	55
Using the Setup Screen Menus	28	Disc Care	55
Changing to the Setup Screen "Expert" Menu Mode	29	For Proper and Long Use of This Unit	56
Setting the Digital Audio Output To Be Compatible with Your AV Component	30	Language Code List	57
Setting Analog Audio Connections to an AV Amplifier or Receiver	31	Troubleshooting	58
Setting Your Speaker System for Multichannel Audio Playback	32	Terms	60
Setting the TV Screen Size	33	Specifications	62
Adjusting the OSD (On-Screen Display)	34		

Before Using

Checking Accessories

Please confirm that the following were received with the player.

Audio cord

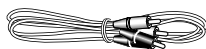

Video cord

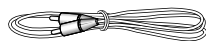

Power cord

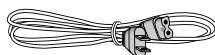

Remote control unit

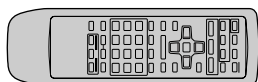

AA/R6P batteries

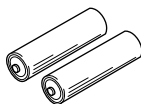

Operating instructions (this manual)

Remote control operation

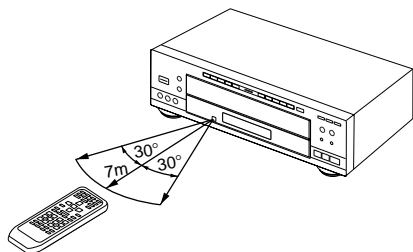

Preparing the Remote Control

Inserting batteries into the remote control

- 1 While pushing the tab on the battery compartment cover toward the center of the remote, pull out in the direction indicated by the arrow.

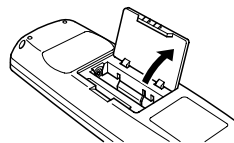

- 2 Insert batteries. Make sure to match the plus (+) and minus (-) polarity guides on the batteries with the marks inside the battery compartment.

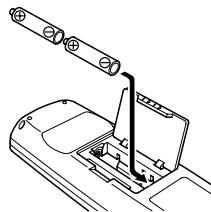

- 3 Close the cover.

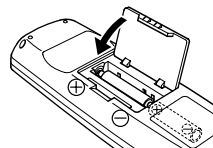

Notes

- Do not mix old and new batteries.
- When replacing batteries, use all new batteries.
- When not using the remote control for a long period of time (over 1 month), remove the batteries to avoid possible damage from battery corrosion. If battery leakage occurs, wipe the battery liquid from the battery component, then insert new batteries.

When operating the remote control, point it at the remote sensor (SR) located on the player's front panel. The remote control can be used up to 23 feet (7 m) from the player and within a 30° angle on each side of the sensor.

Notes

- Exposing the remote sensor to direct sunlight or strong light may cause faulty operation.
- If the CONTROL IN jack on the player's rear panel is connected to the CONTROL OUT jack of another component, point the remote control at the other component to operate the player. Operation will not be possible when pointed at this player (page 19).

Names and Functions

Front Panel

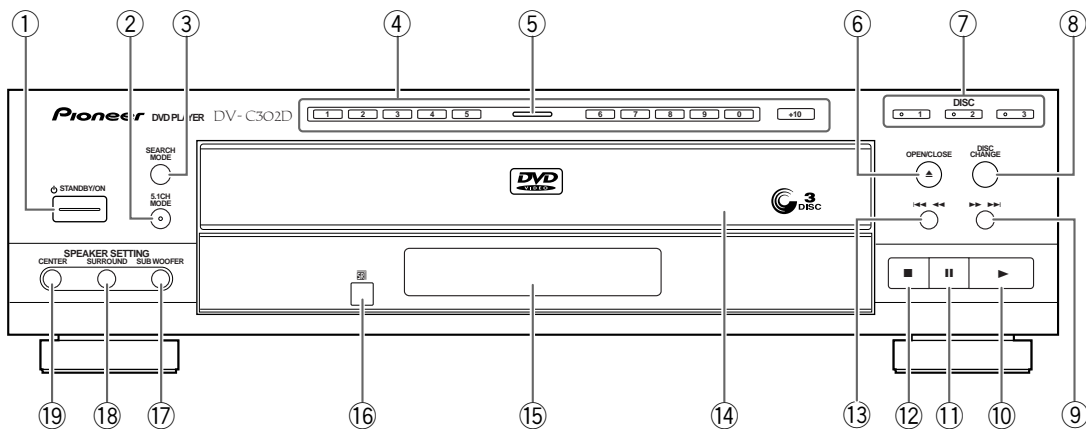

- ① **⏻ STANDBY/ON button**
Press to switch the player on or to put in standby (pages 24, 27 and 54).
- ② **5.1 CH MODE button**
Press to switch the audio output between 5.1 channel audio and 2 channel audio. It is also possible to set the default audio output in the Setup screen **Audio 2** menu (page 31).
- ③ **SEARCH MODE button**
Press to perform a title, chapter/track or elapsed time search (page 42).
- ④ **Number buttons (1-9, 0, +10)***
Use to perform direct title and chapter/track searches, and to input numerical values (pages 25, 42 and 46).
- ⑤ **Disc illumination**
Lights when a DVD is loaded and when no disc is loaded. Turns off when a disc format other than DVD is loaded in the player.
- ⑥ **OPEN/CLOSE ▲ button**
Press to open and close the disc tray (pages 24 and 27).
- ⑦ **DISC button**
Use to select discs in the player directly (page 24).
- ⑧ **DISC CHANGE button**
Press to select the next disc in the player (pages 24 and 27).
- ⑨ **▶▶▶▶ (forward) button**
Press to advance to chapters/tracks. Press and hold to perform fast-forward scanning (page 26).
- ⑩ **▶ (play) button**
Press to start or resume playback (pages 24 and 27).
- ⑪ **⏸ (pause) button**
Press during playback to pause. Press again to resume playback (page 41).
- ⑫ **■ (stop) button**
Press to stop playback. Pressing once enables playback to resume from a point shortly before the location where it stopped. Pressing twice causes the disc to return to the beginning of the disc if playback starts again (page 27).

⑬ **⏮ ⏮ (reverse) button**

Press to go back to previous chapters/tracks. Press and hold to perform reverse playback scanning (page 26).

⑭ **Disc tray**

When loading a disc, place discs in the disc tray with the label side facing up (pages 24 and 27).

⑮ **Display window**

Displays system information (page 11).

⑯ **Remote sensor**

Point the remote control toward the remote sensor to operate the player (page 8).

⑰ **SUB WOOFER button**

Press to turn the SUB WOOFER (LFE) channel on and off when listening to sources being output from the 5.1 channel discrete audio outputs (page 32).

⑱ **SURROUND button**

Press to turn the surround (rear) speaker channels on and off when listening to sources being output from the 5.1 channel discrete audio outputs (page 32).

⑲ **CENTER button**

Press to turn the center speaker channel on and off when listening to sources being output from the 5.1 channel discrete audio outputs (page 32).

Display Window

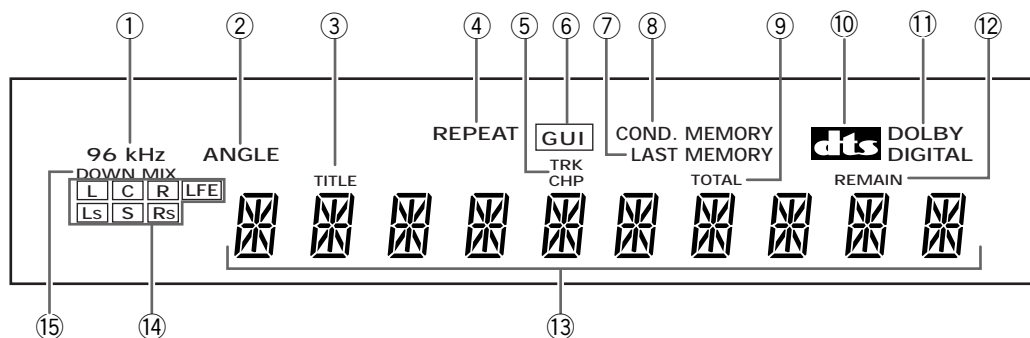

- ① **96 kHz indicator**
Indicates that the currently loaded disc contains an audio signal with a sampling frequency of 96 kHz.
- ② **ANGLE indicator**
Indicates Multi-Angle playback is in progress (page 43).
- ③ **TITLE indicator**
Indicates a title number is being displayed.
- ④ **REPEAT indicator**
Indicates that the Repeat function is on.
- ⑤ **TRK and CHP indicator**
Indicates a chapter or track number is being displayed.
- ⑥ **GUI indicator**
Indicates an on-screen menu operation is being performed (pages 20 and 28).
- ⑦ **LAST MEMORY indicator**
Indicates the Last Memory location is recorded in memory for the currently loaded DVD or Video CD (page 50).
- ⑧ **COND. MEMORY indicator**
Indicates that Condition Memory settings are memorized for the currently loaded DVD (page 51).
- ⑨ **TOTAL indicator**
Indicates that the disc in the player is stopped and **DISPLAY** has been pressed (page 52).
- ⑩ **DTS indicator**
Indicates DTS audio playback.
- ⑪ **DOLBY DIGITAL indicator**
Indicates Dolby Digital audio playback.
- ⑫ **REMAIN indicator**
Indicates that the remaining playback time of a title or chapter/track is being displayed.
- ⑬ **Counter display**
Displays the playback mode, type of disc, title and chapter/track numbers, playback time, etc.
- ⑭ **Program Format indicator**
Depending on the audio format recorded on the disc loaded in the player, the following indicators light to show the channels being played back.
L : Left front^{*1*2}, C : Center^{*1}, R : Right front^{*1*2},
LS : Left surround^{*1}, S : Surround (mono)^{*2},
RS : Right surround^{*1}
^{*1}: Lights to indicate playback of a 5.1 ch Dolby Digital source.
^{*2}: Lights to indicate playback of a Dolby Surround source.

The LFE (low frequency effects) channel indicator indicates 5.1 channel audio that contains a channel for low frequency sounds that are used by the sub woofer.
- ⑮ **DOWNMIX indicator**
During multichannel audio playback, indicates that the output signal has been "downmixed" from the original audio source. This is an automatic function performed by the player in order to present the most appropriate audio mix to the speakers present in your system.

Note

During playback of Dolby Digital karaoke DVDs, the Program Format indicators do not light.

Rear Panel

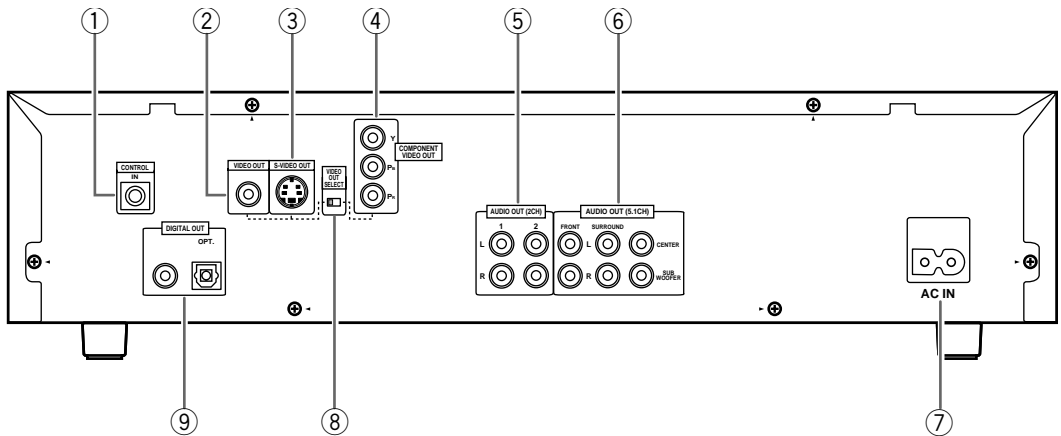

① CONTROL IN jack

Use to connect this player to another component bearing the Pioneer  mark. This lets you control this unit as though it were a component in a system. Player operations are then performed by pointing the remote control at the component that the player is connected to (page 19).

② VIDEO OUT jack

Connect to the video input on a TV or monitor or AV amplifier or receiver with video input capability. When using this jack, be sure to set VIDEO OUT SELECT to the left position (page 19).

③ S-VIDEO OUT jack

If your TV or monitor has an S-video input, clear picture reproduction is possible by connecting the player to your TV or monitor via the S-video jack. When using this jack, be sure to set VIDEO OUT SELECT to the left position (page 19).

④ COMPONENT VIDEO OUT jacks

If your projection monitor, projector or similar component has component video inputs, you can produce a higher quality picture on your projection monitor or projector by connecting to the component video outputs on this unit. When using these jacks, be sure to set VIDEO OUT SELECT to the right position (page 19).

⑤ AUDIO OUT (2 CH) jacks

Use to output two-channel audio (analog) to the audio stereo inputs on a TV or stereo amplifier. If you are connecting to a receiver that has both digital and analog input jacks for DVD player connection, it may be beneficial to make both connections (pages 18).

⑥ AUDIO OUT (5.1 CH) jacks

Use to output 6 discrete audio channels of decoded digital audio to a receiver or amplifier with discrete audio inputs (page 18).

⑦ AC IN power cord connection terminal

Use to connect the power cord to the wall outlet (page 15).

⑧ VIDEO OUT SELECT switch

Use to set which output is used to output the video signals. Select either video/S-video or component video signal output depending on the connections you make (page 19).

⑨ DIGITAL OUT jacks (coaxial, optical (OPT.))

Use to output the digital audio signal recorded on discs. You can output the digital signal via either coaxial or optical output jack to an AV amplifier or receiver (page 17).

Remote Control

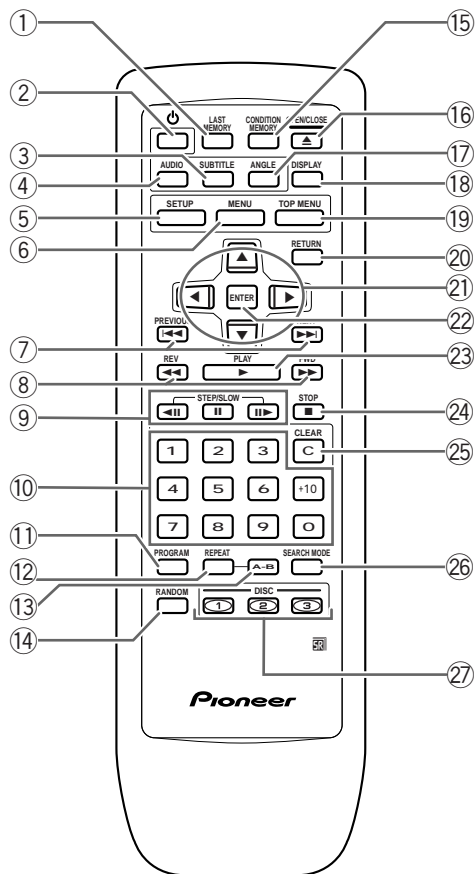

(Buttons indicated with * are used for menu operation.)

① **LAST MEMORY button**

You can resume DVD or Video CD playback from the point you last watched even if the disc is removed from the player. Press **LAST MEMORY** during playback to set a Last Memory point. When you want to resume playback of that disc, press **LAST MEMORY** in the stop mode and playback starts from the memorized point. Last Memory locations can be stored for up to 5 DVDs (or 4 DVDs and 1 Video CD) (page 50).

② **⏻ (standby/on) button**

Press to switch the player on or to put in standby (pages 24, 27 and 54).

③ **SUBTITLE button**

Press repeatedly to select one of the subtitle languages programmed on a DVD or to turn the subtitles off (page 35).

④ **AUDIO button**

Press repeatedly to select one of the audio languages and/or audio formats programmed on a DVD (page 36).

For Video CD and CD, each press changes the audio output as follows.

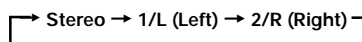

⑤ **SETUP button***

Press when the player is in either play or stop mode to open and close the Setup screen (page 28).

⑥ **MENU button***

Use to display or close the DVD menu screen (page 25).

⑦ **PREVIOUS ◀◀/NEXT ▶▶ buttons**

During playback, press **PREVIOUS ◀◀** to go back to a previous chapter/track and **NEXT ▶▶** to advance to the next chapter/track (page 26).

⑧ **REV ◀◀/FWD ▶▶ (fast reverse/forward) buttons**

During playback of DVD and Video CD, press **FWD ▶▶** to perform fast forward scanning. Press **REV ◀◀** to perform fast reverse scanning of DVD and Video CD. When a CD is loaded, audio scanning is performed (page 26).

⑨ **STEP/SLOW ◀||/||▶ buttons**

Press **||** during playback to pause playback of disc. Press again to resume playback (page 41)

Press **STEP/SLOW ||▶** during playback to view slow playback. In pause mode, press **STEP/SLOW ||▶** to advance DVDs and Video CDs frame by frame and **STEP/SLOW ◀||** to back up a few frames at a time (page 41).

- ⑩ **Number buttons (1-9, 0, +10)***
Use to perform direct title and chapter/track searches, and to input numerical values (pages 25, 42 and 46).
- ⑪ **PROGRAM button**
You can program discs, titles, chapters or tracks to play back in a desired order. Programs can be a maximum of 24 steps (page 46).
- ⑫ **REPEAT button**
During playback of a DVD, press once to repeat playback of the current chapter, and twice to repeat playback of the current title. During playback of a Video CD or CD, press once to repeat playback of the current track, twice to repeat playback of the current disc, and 3 times to repeat all the discs loaded in the player (page 44).
- ⑬ **A-B button**
Press at the beginning and end of the section you want to repeat or to mark a location you want to return to (page 44).
- ⑭ **RANDOM button**
Press to play discs, titles, chapters or tracks in random order (page 45).
- ⑮ **CONDITION MEMORY button**
You can store in memory the settings for up to 15 DVDs. Press **CONDITION MEMORY** during DVD playback to memorize the settings (page 51).
- ⑯ **OPEN/CLOSE ▲ button**
Press to open or close the disc tray (pages 24 and 27).
- ⑰ **ANGLE button**
Some DVDs are recorded with various camera angle playback options. Press **ANGLE** repeatedly to display different camera angles (page 43).
- ⑱ **DISPLAY button**
Press during playback to display statistical disc information. Press repeatedly to display different information (page 52).
- ⑲ **TOP MENU button***
Press to call up the top menu programmed on the DVD. Depending on the DVD, the top menu may be identical to the DVD menu (page 25).
- ⑳ **RETURN button***
Use to go one menu back (current settings are maintained). Use **RETURN** when you do not want to change the option setting in a menu (pages 25, 29, and 49).
- ㉑ **Cursor buttons (◀/▶/▲/▼)***
Use to move through the options on menu screens and to change settings (pages 20, 24, 28 and 46).
- ㉒ **ENTER button***
Use to implement settings selected with the cursor buttons or to set items highlighted in a menu (pages 20, 24, 28 and 46).
- ㉓ **PLAY ► button**
Press to start disc playback (pages 24 and 27).
- ㉔ **STOP ■ button**
Press to stop playback. Pressing once enables playback to resume from a point shortly before the location where it was stopped. Pressing twice causes the disc to return to the beginning of the disc when playback starts again (page 27).
- ㉕ **CLEAR button**
Works in conjunction with a number of player functions. Use to cancel repeat and random playback, and to edit programs (pages 44, 45 and 46).
- ㉖ **SEARCH MODE button**
Press to perform a title, chapter/track or elapsed time search (page 42).
- ㉗ **DISC buttons (1-3)**
Use to select discs in the player directly (pages 24).

Making Connections

Connecting Your DVD Player

Unlike any other audiovisual media format, DVD offers a wide array of audio and video output options which allows playback to be enjoyed in any number of system configurations from a standard TV with stereo audio input to a home theater system with a projection monitor and full surround sound capabilities.

Connection Guide

The illustration on this page shows the basic setup using the audio and video cords included with this player. Use this illustration as a guide to setting up your home system.

An explanation of each type of audio and video connection available can be found on pages 17 to 19. To determine the best audio and video connection setup for your system, refer to the manuals supplied with the components you are making connections to.

In addition to making physical connections to your TV or monitor, it is also necessary to assign the TV screen size. You can use the [Setup Navigator] in the Setup screen **General** menu to set whether you are using a wide screen or standard size TV or monitor (page 21). Additionally, you can use the [TV Screen] setting in the Setup screen **Video** menu (page 33).

Notes

- When making connections to this unit or when changing connections, check that the unit is off by pressing **STANDBY/ON** making sure that nothing is being displayed in the display window, and then unplug the power cord from the power outlet.
- The video output on this player uses copy protect circuitry to prevent the video playback on DVDs from being copied. If you connect the player to a TV via a VCR, or record and play back the contents of a disc with a VCR, the playback picture may not be normal.

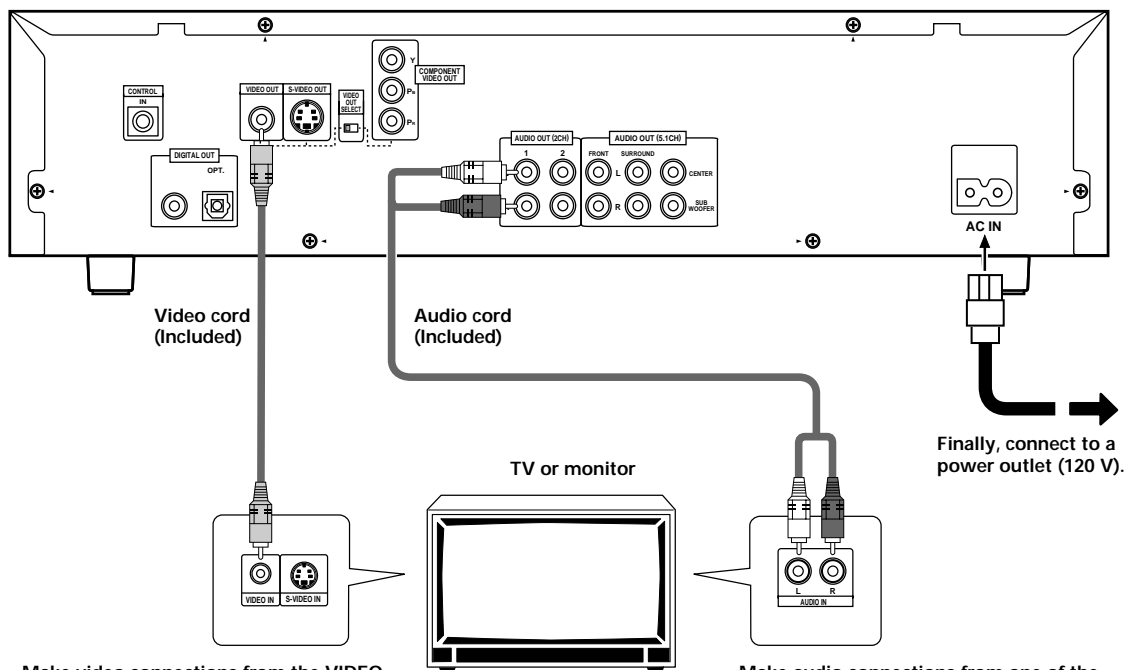

Make video connections from the VIDEO OUT jacks on the player to the VIDEO IN jack on the TV or monitor using the video cord included with the player.

Make audio connections from one of the AUDIO OUT jacks on the player to the AUDIO IN jacks on the TV or monitor using the stereo audio cord included with the player. Be sure to match the color of the plugs with the color of the jacks (red and white).

Home Theater Component Connections

The connections on this page demonstrate the versatility of this player to conform to any number of home entertainment systems.

Please note that the illustration shown on this page is meant as an example. Please refer to the manuals supplied with the components to which you are making connections to determine the best possible setup for your home system.

An explanation of each type of audio and video connection available can be found on pages 17 to 19.

S-video connection produces a high quality video image. If you have a TV or monitor that features an S-video input, make video connections from the S-VIDEO OUT jack on the player to the S-VIDEO IN jack on the TV or monitor using an S-video cord (not included) (page 19).

TV or monitor

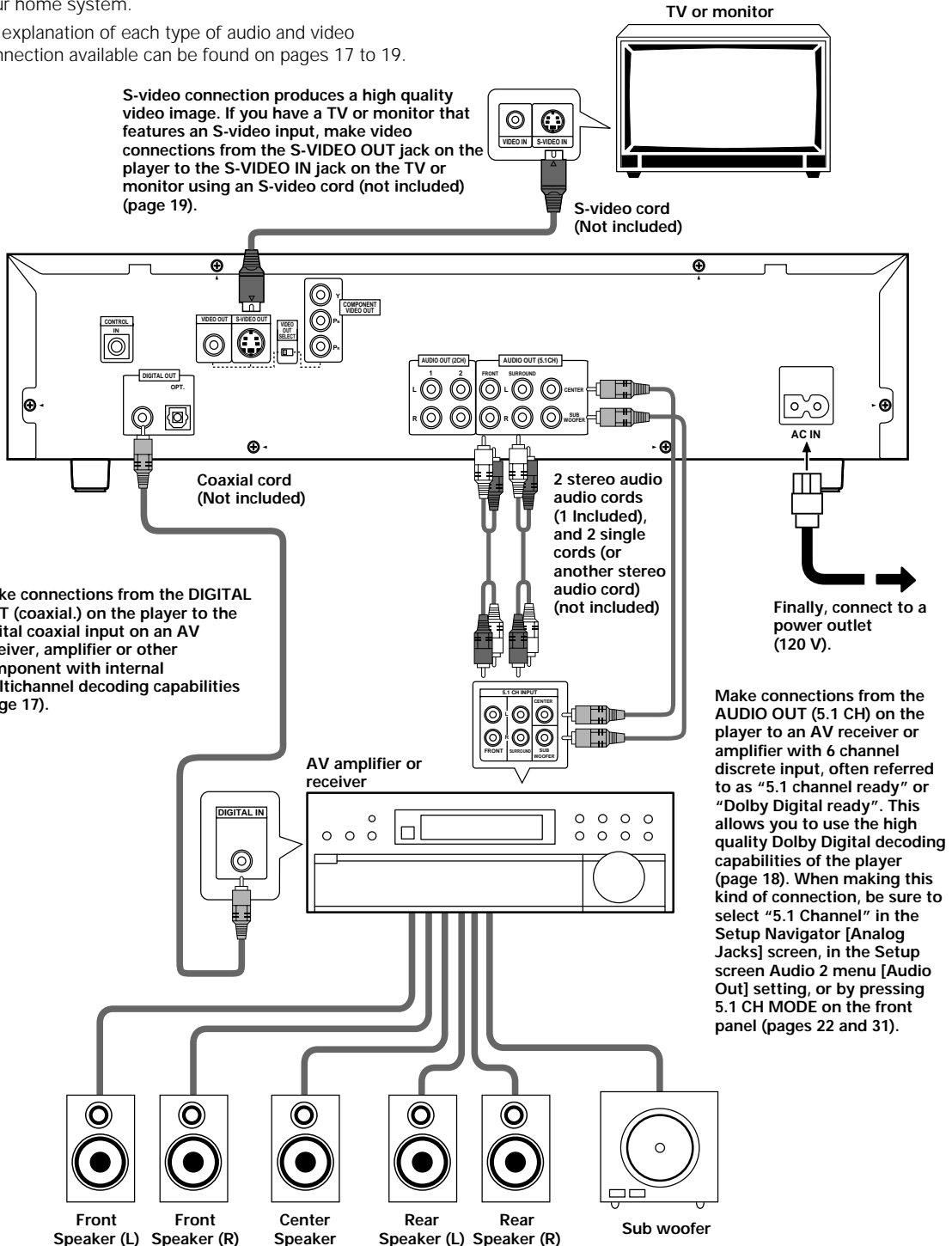

Make connections from the DIGITAL OUT (coaxial) on the player to the digital coaxial input on an AV receiver, amplifier or other component with internal multichannel decoding capabilities (page 17).

2 stereo audio audio cords (1 Included), and 2 single cords (or another stereo audio cord) (not included)

Finally, connect to a power outlet (120 V).

Make connections from the AUDIO OUT (5.1 CH) on the player to an AV receiver or amplifier with 6 channel discrete input, often referred to as "5.1 channel ready" or "Dolby Digital ready". This allows you to use the high quality Dolby Digital decoding capabilities of the player (page 18). When making this kind of connection, be sure to select "5.1 Channel" in the Setup Navigator [Analog Jacks] screen, in the Setup screen Audio 2 menu [Audio Out] setting, or by pressing 5.1 CH MODE on the front panel (pages 22 and 31).

Audio Connections

This player features two digital (optical and coaxial) and also analog 2 channel and 5.1 channel audio output connection possibilities.

Digital Audio Connections:

You can enjoy the digital audio recorded on DVD discs from both optical digital and coaxial digital output jacks.

When making digital audio connections, do not make connections from both the coaxial and optical digital outputs to the same component.

When a DVD recorded in Dolby Digital, DTS, or MPEG is loaded, noise will be output if you have made connections via the digital audio jacks to a receiver or amplifier that cannot decode a Dolby Digital, DTS, or MPEG digital bitstream. In this case, be sure to set the [Digital jack] setting in the Setup Navigator to best reflect the type of system you are using. (page 23) Additionally, the digital audio settings can be adjusted manually in the Setup screen **Audio 1** menu (page 30).

DIGITAL OUT (Optical)

The digital signal is transmitted as light pulses through a fiber-optic cable.

- Use to connect to an AV amplifier or receiver with built-in Dolby Digital, DTS, or MPEG decoder.
- Use a fiber-optic cable (not supplied) to connect the digital optical output on the player to the digital optical input on an AV amplifier or receiver.

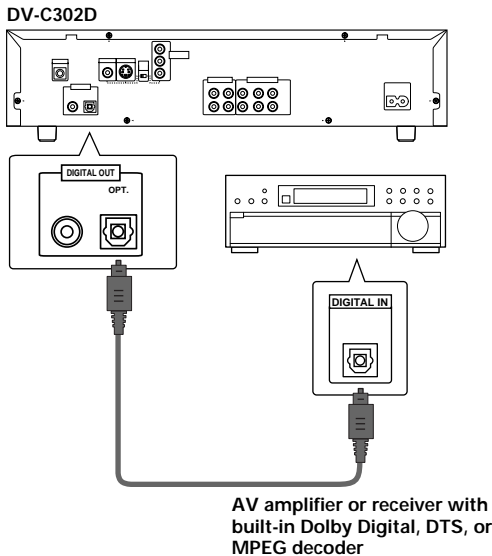

DIGITAL OUT (Coaxial)

The digital signal is transmitted electronically through a coaxial cable.

- Use to connect to an AV amplifier or receiver with built-in Dolby Digital, DTS, or MPEG decoder.
- Use a coaxial cable (not supplied) to connect the coaxial digital output on the player to the coaxial digital input on an AV amplifier or receiver.

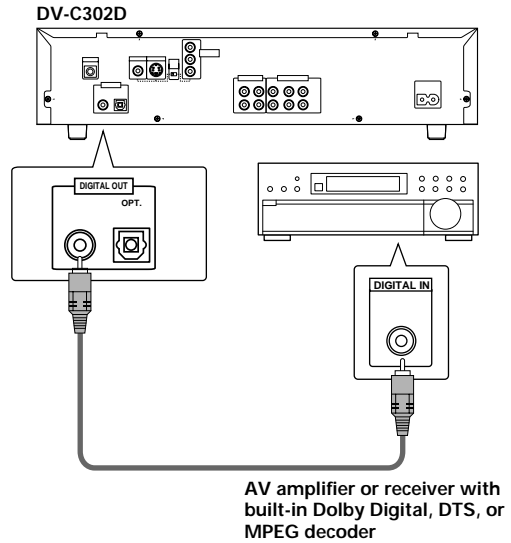

Analog Audio Connection:

After making physical connections to either the AUDIO OUT (2 CH) or AUDIO OUT (5.1 CH) analog jacks, be sure to identify which output you are going to be using in the [Analog Jacks] screen of the Setup Navigator (page 22). You can also manually set the output in the [Audio Out] setting of the Setup screen **Audio 2** menu (page 31).

Notes

- When "5.1 Channel" is selected, the front right (R) and front left (L) audio channels output from the AUDIO OUT (2 CH) analog jacks (page 32).
- The [Audio Out] setting creates an audio output default for the player. If connections are made to both AUDIO OUT (2 CH) and AUDIO OUT (5.1 CH) analog jacks to make different audio connections for multichannel and stereo audio sources, it is possible to switch between 2 channel and 5.1 channel audio output by pressing **5.1 CH MODE** on the front panel. However, this button does not work when the GUI indicator is lit.

2 CHANNEL AUDIO OUT

- Make analog audio connections to a stereo amplifier or receiver.
- Analog audio connections can also be made to a TV or monitor with stereo input jacks.
- Use the supplied audio cable to connect one of the AUDIO OUT (2 CH) analog jacks on the player to the audio input on the stereo amplifier or receiver.
- When making analog audio connections, be sure to match the color of the plugs with the color of the jacks (red and white).
- When making this kind of connection, be sure to press 5.1 CH MODE on the front panel to select 2 channel analog audio output (pages 22 and 31).

DV-C302D

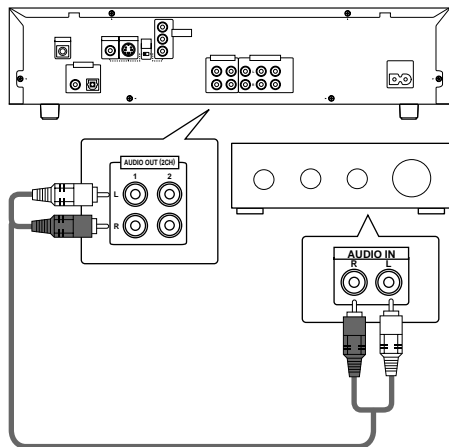

Stereo amplifier or receiver

5.1 CHANNEL AUDIO OUT

5.1 channel audio refers to the current industry surround sound standard requiring two front speakers, a center speaker, two surround (rear) speakers and a sub woofer. Although in actuality there are 6 channels, because the sub woofer channel, or LFE channel, makes up a mere fraction of the total audio soundtrack, it has been designated as the 0.1 of the 5.1 system.

By utilizing the player's internal multichannel audio decoder, the audio of Dolby Digital DVDs can be output from the 5.1 channel discrete outputs to an AV amplifier or receiver with 5.1 channel input capability.

- Use audio cables to make connections from the player's AUDIO OUT (5.1 ch) jacks to the equivalent input jacks on the AV amplifier or receiver.
- When making 5.1 channel analog audio connections, be sure to match the left and right channels on both components, and also make sure that the jacks of all the channels are connected correctly on both components.
- Either 2 single audio cords or a stereo cord may be used to connect the CENTER and SUB WOOFER channels to the AV amplifier or receiver.
- When making this kind of connection, be sure to press 5.1 CH MODE on the front panel to select 5.1 channel analog audio output (pages 22 and 31).

DV-C302D

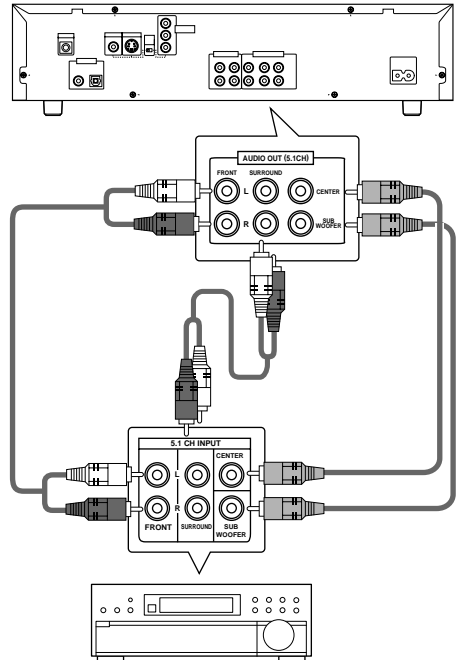

AV amplifier or receiver

Video Connections

This player features S-video, composite video and component video output possibilities. Check the manual supplied with your TV or monitor to determine the best possible connection for your system.

In addition to making physical connections to your TV or monitor, it is also necessary to assign the TV screen size. You can use the [Setup Navigator] in the Setup screen **General** to set whether you are using a wide screen or standard size TV or monitor (page 21). Additionally, you can use the [TV Screen] setting in the Setup screen **Video** menu (page 33).

S-VIDEO OUT

- Make S-video connections to a TV or monitor with S-video input to produce a high quality video image.
- Use an S-video cable (not supplied) to connect one of the S-VIDEO OUT jacks on the player to the S-video input on the TV or monitor.
- When using this jack, be sure to set VIDEO OUT SELECT to the left position.

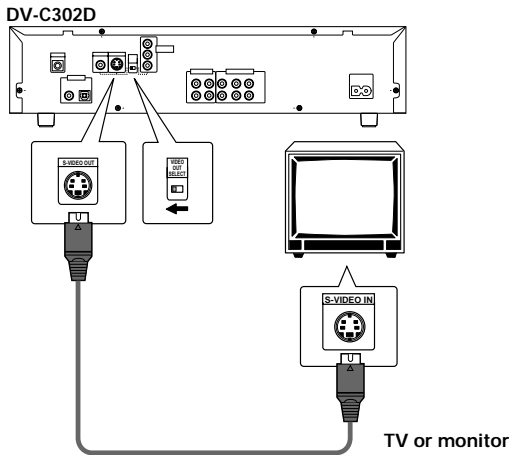

VIDEO OUT

- Make composite video connections to a standard TV or monitor with a video input jack.
- Use the supplied video cable to connect one of the VIDEO OUT jacks on the player to the video input on the TV or monitor.
- Be sure to match the color of the plug with the color of the jack (yellow).
- When using this jack, be sure to set VIDEO OUT SELECT to the left position.

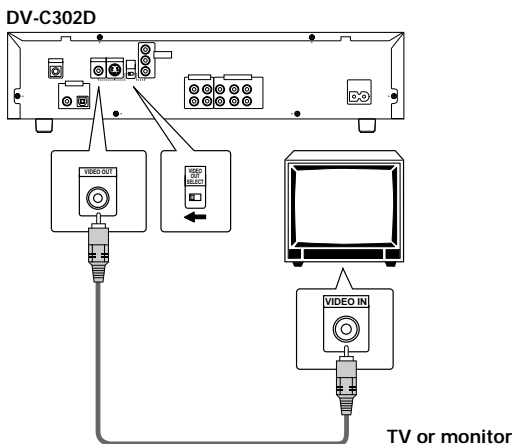

COMPONENT VIDEO OUT

- Make component video connections to a projection monitor, projector or TV with component inputs to produce a higher quality video image.
- Use component video cables or 3 video cords (not supplied) to connect the COMPONENT VIDEO OUT jacks on the player to the component jacks on the monitor.
- When making component video connections, make sure to set the VIDEO OUT SELECT switch on the rear panel of the player to the right to assign component video output.

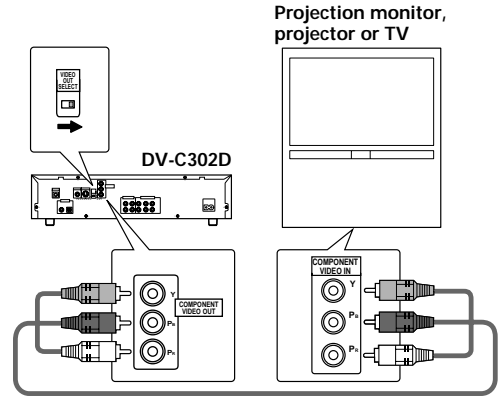

System Control Connections

Using a commercially available cord with a mini plug (3.5 mm dia. with no resistance) to connect this player's CONTROL IN jack to the CONTROL OUT jack of another PIONEER component bearing the **SR** mark, you can control the player as though it were a component in a system (system control).

- If you connect for system control, you cannot operate the player directly. Point the remote control unit at the component (AV amplifier, etc.) connected to the CONTROL OUT jack to operate.
- When controlling as a system, be sure to make a connection to the amplifier **using an audio or video cord**, even when using only digital components.
- For details, refer to the operation manuals of the connected components.

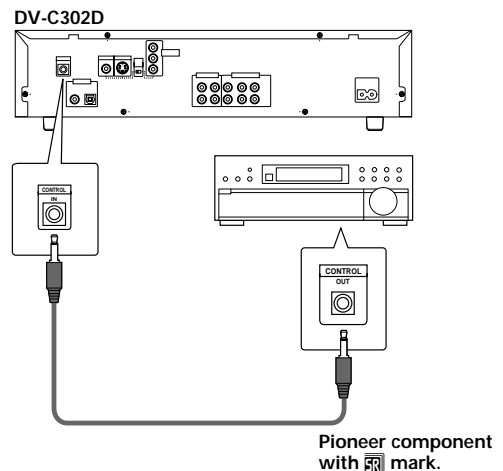

Setting Up the Player

Using the Setup Navigator

The Setup Navigator has been designed to simplify the process of getting the DVD player ready to perform. Designed as a series of on-screen multiple-choice questions, the Setup Navigator automatically sets the audio, video and language settings according to how the questions are answered. Once this procedure is complete, it will be possible to begin using the DVD player to enjoy DVDs.

The procedure on this page describes the operations necessary to function within the Setup Navigator screens. A detailed description of the contents of each question that appears on the screen can be found on the following page.

When setting up for the first time

Some DVDs start playing automatically when loaded in the player. Because the Setup Navigator cannot be used if a disc is playing, it is recommended to set up the player using the Setup Navigator before loading a DVD for the first time. If a DVD has been loaded, be sure to press **STOP** ■ before proceeding.

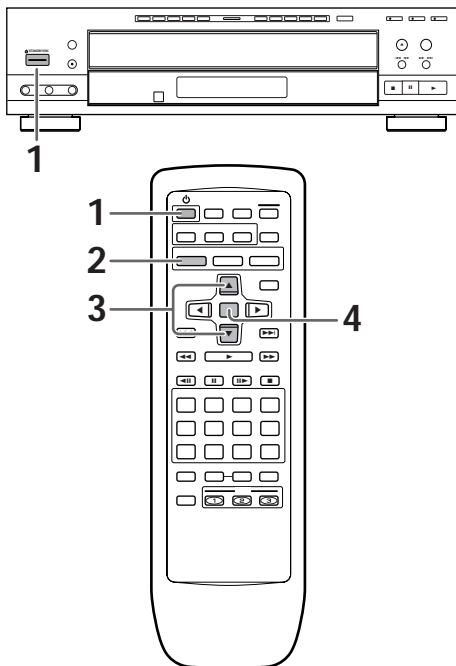

1 Press **⏻** (⏻ **STANDBY/ON** on the front panel) to turn the player on.

2 Press **SETUP**.

When **SETUP** is pressed for the first time, the following screen appears. Though the Setup Navigator may be used more than once, this screen only appears the first time **SETUP** is pressed.

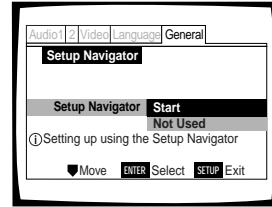

3 Use the cursor buttons (**▲/▼**) to make a selection.

- If you are going to use the Setup Navigator, it is not necessary to change the setting on the first screen. Please proceed to the next step.
- If you want to set up the player without using the Setup Navigator, use the cursor button (**▼**) to select "Not Used" at this time. The Setup Navigator function may still be used at a later time in manual Setup screen menu operation (page 29).

4 Press **ENTER**.

The selection is entered and the next Setup Navigator screen appears.

Use steps 3 and 4 as a basis for entering selections on the all of the Setup Navigator screens described on the following pages.

To change the answer to a prior question

Use the cursor button (**◀**) to return to previous screens. Please note, however, that you cannot go forward using the cursor button (**▶**), so it will be necessary to answer all the questions that occur after the screen that was returned to.

To exit the Setup Navigator

Press **SETUP** while on any of the screens to exit the Setup Navigator. Please note that if the Setup Navigator is exited before all the questions are answered, no settings are changed.

To return to the Setup screen

Press **RETURN**. The Setup Navigator is exited and the Setup screen **General** menu screen appears. Please note that no settings are changed if **RETURN** is pressed before the Setup Navigator is finished.

Setting the OSD Language (On-Screen Display Language)

The [OSD Language] screen establishes the OSD language, or on-screen display language, which refers to the language that is used by the player in menus and on-screen messages. Additionally, the language that is established at this setting will also be used for the default audio and subtitle language.

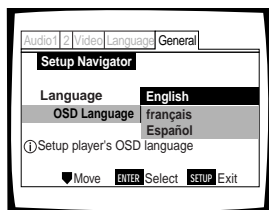

Settings: **English***
français
Español

* Factory setting

Note

In addition to setting the OSD language, the audio and subtitle language are also set at this time. If you wish to change the audio or subtitle language to a different language, make changes in the Setup screen **Language** menu [Audio Language] and [Subtitle Language] as needed (page 35).

Setting the TV screen size

The [TV Type] screen establishes the size, or more appropriately the width to height ratio of your television or monitor. The width-to-height ratio of conventional TVs is 4:3, while the width-to-height ratio of wide screen and high-definition TVs is 16:9. This width-to-height ratio is called the aspect ratio.

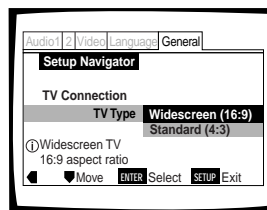

Settings: **Widescreen (16:9)***
Standard (4:3)

* Factory setting

Note

There are two screen formats that can be used to display wide-screen format DVDs: letter box and pan&scan. When "Standard (4:3)" is selected in the Setup Navigator, the letter box screen format is automatically selected. To switch the preference to the pan&scan format, make changes in the Setup screen **Video** menu [TV screen setting] (page 33).

Setting analog audio connections to an AV amplifier or receiver

The [Analog Jacks] screen establishes whether analog connections have been made to an AV amplifier or receiver, and if connections are made, whether the connections made are for 2 channel stereo or for 5.1 channel surround sound.

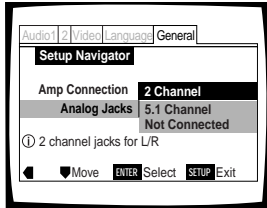

Settings: **2 Channel***

Select if you have made 2 channel connections to an amplifier or receiver.

5.1 Channel

Select if you have made 5.1 channel connections to an AV amplifier or receiver with the appropriate inputs. When this setting is selected, several screens will follow to determine the configuration of your speaker system. These screens are described below in the section 'To coordinate your speaker system for 5.1 channel output'.

Not Connected

Select if you have not made analog audio connections.

* Factory setting

To coordinate your speaker system for 5.1 channel output

When "5.1 Channel" is selected in the [Analog Jacks] screen, the following screens appear to determine the configuration of your speaker system. In all of the following screens, select "Present" if the speaker in question is present in your system, and "Not Present" if it is not.

[Center Speaker]

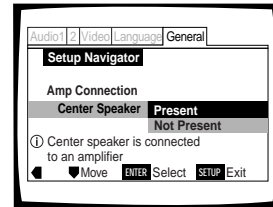

[Surround Speakers]

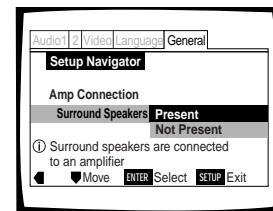

[Sub-woofer]

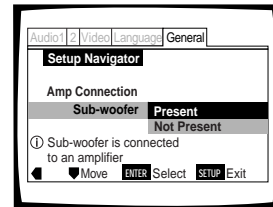

Settings: **Present***

Not Present

* Factory setting

Note

(If "Not Present" is selected for both [Center Speaker] and [Surround Speaker], [Sub-woofer] is automatically set to "Not Present" and the [Sub-woofer] screen is not displayed.

Setting digital audio connections to an AV amplifier or decoder

The [Digital Jack] screen establishes whether digital connections have been made to an AV amplifier, receiver, or external decoder. As there are numerous options available, please refer to the instructions supplied with the component the player is connected to to determine what digital audio formats can be decoded. If you have made no digital connections, select "Not Connected".

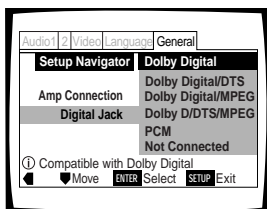

- Settings:
- Dolby Digital***
 - Dolby Digital/DTS**
 - Dolby Digital/MPEG**
 - Dolby D/DTS/MPEG**
 - PCM**
 - Not Connected**

* Factory setting

Confirming the settings

The [Exit Setup Navigator] is the final screen in the Setup Navigator.

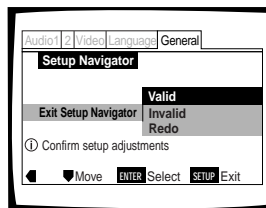

Settings: **Valid***

Select to have the player make all of the necessary audio, video, and language settings according to your responses in the Setup Navigator.

Invalid

Select to exit the Setup Navigator without changing any of the system settings.

Redo

Select to return to the [OSD Language] screen of the Setup Navigator and do the settings again.

* Factory setting

Setting compatibility with 96 kHz output

The [96 kHz PCM Audio] screen establishes whether or not the AV component the player is connected to is capable of processing an audio signal with a sampling rate of 96 kHz. This screen only appears if connections have been made to an external AV component as determined in previous screens.

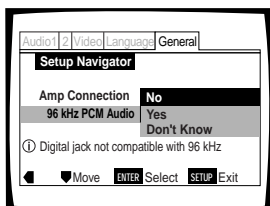

Settings: **No***

Select if the connected AV component cannot process an audio signal with a sampling rate of 96 kHz.

Yes

Select if the connected AV component can process an audio signal with a sampling rate of 96 kHz.

Don't Know

Select if you are uncertain whether the connected AV component can process an audio signal with a sampling rate of 96 kHz.

* Factory setting

To exit the Setup screen

When you have completed setting up the player using the Setup Navigator or if you exit the Setup Navigator, the Setup screen **General** menu appears. Press **Setup** to close the Setup screen.

To change other player settings in the Setup screen menus

The procedure for changing the settings in the Setup screen menus is described on page 28 and 29.

Getting Started Using Your DVD Player

Playing DVDs, Video CDs and CDs – DVD/Video CD/CD

Before you can start to enjoy the digital audio and video on DVDs, be sure that you have either performed the Setup Navigator procedure described in the previous section or made the necessary settings in the Setup screen menus as outlined in the next section to set up the player to correspond to your home system. Having made these settings, you are now ready to start using the player to enjoy DVDs, Video CDs, and CDs.

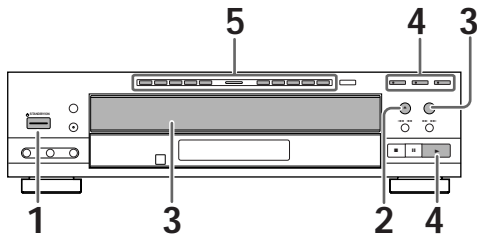
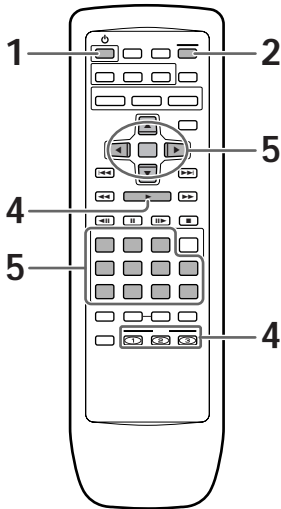

- 1 Press **⏻** (**STANDBY/ON** on the front panel) to turn on the player.

- 2 Press **OPEN/CLOSE** (**⏪** on the front panel). The disc tray comes out.

- 3 Load a disc.
 - Load a disc with the label side facing up, using the disc tray guide to align the disc.
 - Labels indicating disc numbers (1 through 3) are affixed to the disc table. Press the **DISC CHANGE** to rotate the disc tray and then load a disc on to the disc table.

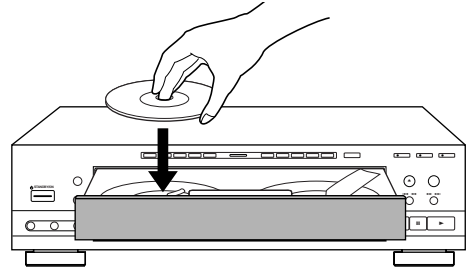

- The number of the **DISC** buttons (1 through 3) correspond with the numbers on the labels affixed to the disc table

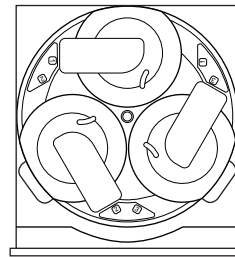

- 4 Press **PLAY** (**▶** on the front panel).
 - The disc located in the front and to the left of the disc table is played.
 - Press one of the **DISC** buttons (1 through 3) to begin playback of the selected disc.
 - **Depending on the disc, a menu may be displayed. If a menu is displayed, proceed to step 5.**

- 5 Select the item you want to view.
 - When a DVD is loaded:
Use the cursor buttons (**⏪**/**▶**/**▲**/**▼**) to select the item, then press **ENTER**. You may also be able to use the number buttons for direct selection (Depending on the disc, you may not be able to use the number buttons).
 - When a Video CD is loaded:
Use the number buttons to select the item.

Notes

- Noise is output if you make digital audio connections to a receiver or amplifier that does not have a built-in decoder. Check that the digital audio output format selected in the **Audio 1** menu corresponds to the audio components you have made connections to (page 30).
- The TV screen size is factory set to present the wide screen format (16:9 aspect ratio). If you have a standard TV screen (4:3 aspect ratio), this setting can be changed to match your TV screen size in the **Video** menu (page 33).

When a menu screen is displayed

Menu screens are displayed for DVDs that have menu screens or Video CDs that include Playback Control (PBC). DVDs often contain extra information that can be accessed in the DVD menu and sometimes makes navigating DVD menu screens as enjoyable as watching the feature presentation.

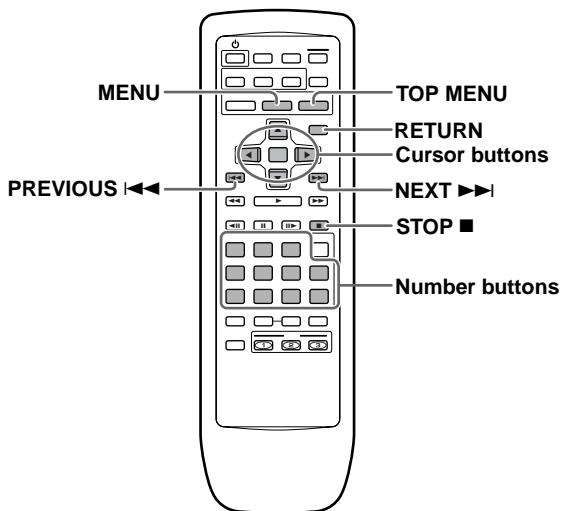

Example: When a DVD that has menu screens is loaded

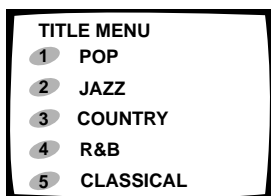

Example: When a Video CD that has Playback Control is loaded

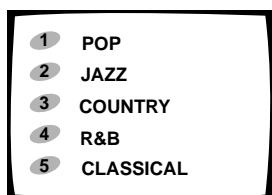

To open or return to the DVD or Video CD menu screen

Although this differs depending on the disc, pressing **MENU**, **TOP MENU**, or **RETURN** during DVD playback or **RETURN** during Video CD playback displays the menu screen. Refer to the DVD or Video CD disc jacket and accompanying documentation for more information.

To navigate a menu screen

- Although individual DVD titles may differ, when a menu screen is displayed, use the cursor buttons (◀/▶/▲/▼) and **ENTER** on the remote control. The cursor buttons are used to move around the options on the screen and **ENTER** is used for selection.
- Occasionally, the number buttons may also be used to make selections. If this is possible, using number buttons serves to directly select an option on a menu screen. Only number buttons are used to make selections on Video CD menu screens.
- When the Video CD has more than one menu, pages can be advanced to or returned to with **PREVIOUS** ◀◀ or **NEXT** ▶▶.

To play Video CDs without displaying menu screens

Video CDs with Playback Control (PBC) display a menu screen when play is started. It is possible, however, to playback Video CDs without displaying menu screens.

When a Video CD with PBC is loaded, press **STOP** ■, and then the number button of the track you want to play.

To change discs that are not currently playing

- If the **OPEN/CLOSE** ▲ is pressed while a disc is playing, the disc table opens so that other discs can be changed. However, when desiring to change the disc that is currently playing, open the disc table after first interrupting playback. The disc to be changed will be located towards the front on the left side of the disc table.
- Although there may be disturbances in the sound or picture when opening or closing the disc table while playback is in progress, this is not a malfunction.

When an operation is prohibited

There are times when you are using the player and attempt to perform an operation, but for some reason it cannot be performed. When this occurs, one of the two following icons appears on the screen.



The operation is prohibited by the player.



The operation is prohibited by the programming on the disc.

Auto Power on Function

Pressing any of the below buttons when the power is standby automatically turns the power on.

PLAY, OPEN/CLOSE*, DISC*, LAST MEMORY.

* These buttons are provided on the main unit only.

Chapter (Track) Skip Forward/ Skip Back – DVD/Video CD/CD

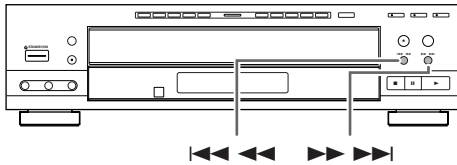
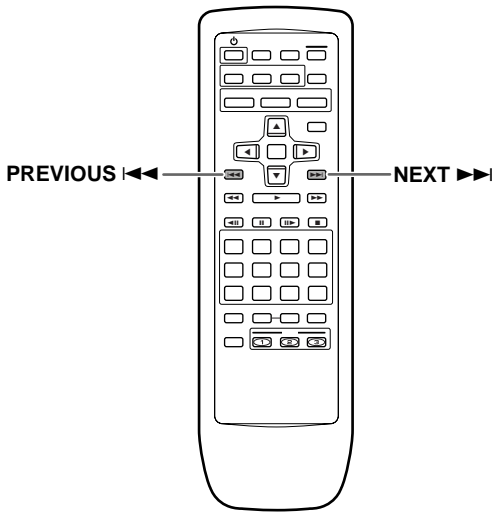

Advancing to the next chapter (track)

Press **NEXT** ►► (►► ►► on the front panel).

- Press to skip forward to the next chapter (track).
- When a CD is loaded, you can advance more than one track forward by pressing and holding **NEXT** ►► and releasing when the desired track number appears in the display.

Skipping back to the previous chapter (track)

Press **PREVIOUS** ◄◄ (◄◄ ◄◄ on the front panel).

- Press once to skip back to the start of the chapter (track) currently playing.
- Press twice to skip back to the start of the previous chapter (track).
- When a CD is loaded, you can skip back to the track you want to hear by pressing and holding **PREVIOUS** ◄◄ and releasing when the desired track number appears in the display.

Forward and Reverse Scanning

– DVD/Video CD/CD

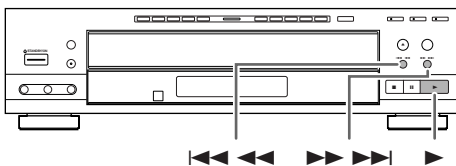
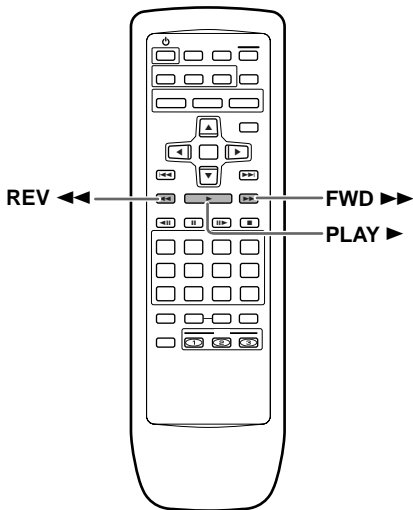

Fast forward scanning

Press and hold **FWD** ►► (►► ►► on the front panel) during playback.

- Release **FWD** ►► when you reach the desired location. Normal playback resumes.
- When the "Scan" indicator on the screen changes from flashing to lit, fast forward scanning will continue even if the button is released. When the desired location has been reached, press **PLAY** ►.

Fast reverse scanning

Press and hold **REV** ◄◄ (◄◄ ◄◄ on the front panel) during playback.

- Release **REV** ◄◄ when you reach the desired location. Normal playback resumes.
- When the "Scan" indicator on the screen changes from flashing to lit, fast reverse scanning will continue even if the button is released. When the desired location has been reached, press **PLAY** ►.

Stopping Playback and Switching Power Off

– DVD/Video CD/CD

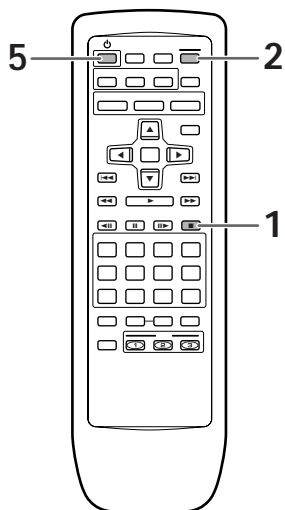

- 1 Press **STOP** ■ (■ on the front panel). Playback stops.
- 2 Press **OPEN/CLOSE** ▲ (▲ on the front panel).
 - The disc table comes out.
 - The tray rotates and the disc that was playing is located towards the front on the left side of the table.
- 3 Remove the discs.

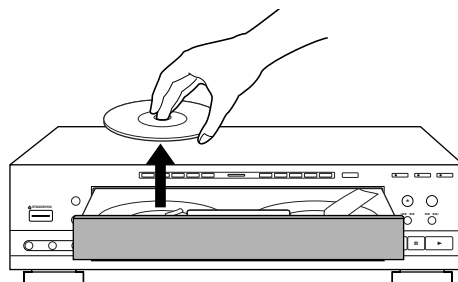

- 4 Press the **DISC CHANGE** to remove all discs.
- 5 Press **⏻** (⏻ **STANDBY/ON** on the front panel).

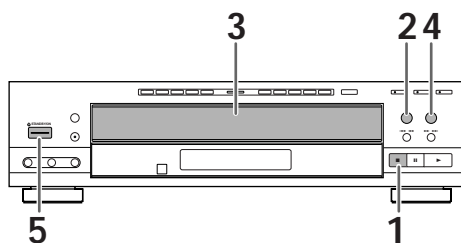

Resuming playback from where you stopped — DVD/Video CD

With this player, it is possible to resume play of a DVD or Video CD when play has been stopped.

Press **STOP** ■ once to enable play to resume from a point shortly before the DVD/Video CD was stopped when **PLAY** ► is pressed again.

- To begin disc playback from the beginning, press **STOP** ■ twice to turn off resume playback, and then start playback again.
- Pressing **STOP** ■ twice causes the disc to return to the beginning when **PLAY** ► is pressed again.

Note

Resume play is only possible when the disc is loaded and **STOP** ■ has not been pressed twice in succession ("RESUME" appears in the display). If you want to continue viewing a DVD at a later time or date, it is recommended to use the Last Memory function described on page 50.

Adjusting Audio and Video Settings

Using the Setup Screen Menus

The procedure on page 28 and 29 describes how to operate the menus on the Setup screen. These menus are used to set and adjust a number of system settings. The various functions that can be adjusted are covered throughout this manual. The procedure on this page provides a basic outline for using the Setup screen menus.

When setting up for the first time

It is recommended to set up player using the [Setup Navigator] (page 20). If you selected "Not Used" when the [Setup Navigator] appears, you may still set up the player using the [Setup Navigator] in the **General** menu screen.

If you choose not to use the [Setup Navigator], be sure to make the necessary settings in the Setup screen **Audio 1**, **Audio 2**, **Video**, and **Language** menus as described on the following pages.

Some DVDs start playing automatically when loaded in the player. If a DVD has been loaded, be sure to press **STOP** ■ before proceeding.

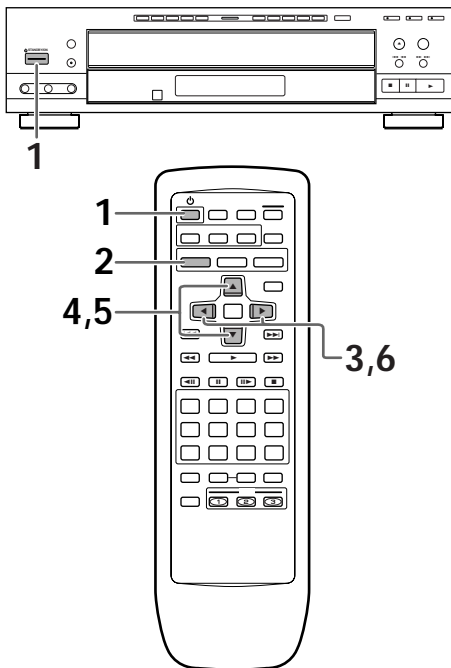

- 1 Press **⏻** (⏻ **STANDBY/ON** on the front panel) to turn the player on.

- 2 Press **SETUP**.
The Setup screen appears.

(Example)

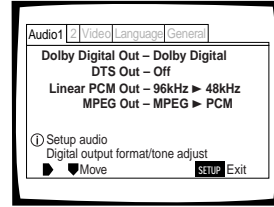

- 3 Use the cursor buttons (◀/▶) to select the menu you want.

As each menu is selected with the cursor, the settings appear below the menu heading.

- 4 Press the cursor button (▼) to enter the menu.

The top item within the menu becomes highlighted.

(Example)

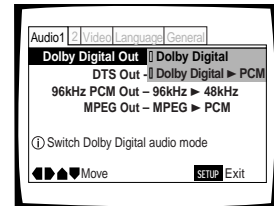

- 5 Use the cursor buttons (▲/▼) to select the setting you want to change.

The options available for each setting appear to the right when the setting is selected. The current setting appears with the setting indicator lit.

- 6 Press the cursor button (▶) to enter the setting options.

(Example)

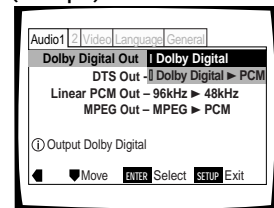

- Not all menu options can be changed while a disc is playing. In these cases, the options appear grayed out on the screen and cannot be adjusted. To change these settings, press **STOP** ■ first before pressing **SETUP**.
- Operating the menu after pressing **STOP** ■ may cancel the resume function.
- Some menu options are not immediately effective if set while a disc is playing. To make these settings effective, stop playback and then start again, or change the settings while the disc is stopped.

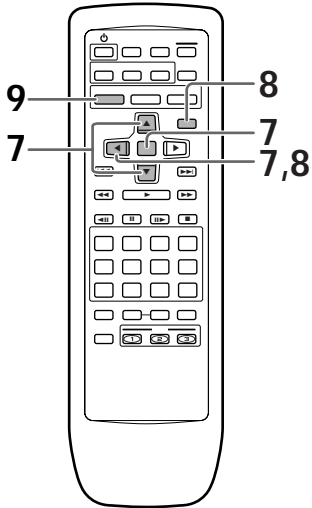

IMPORTANT

Changing the Setup Screen to “Expert” Menu Mode

The Setup screen menus are divided into two levels, “Basic” and “Expert”, to make this unit more convenient to operate for different levels of users. The “Basic” menu mode contains functions that may be considered necessary for the basic operations of this player and helpful on-screen information identified by the ⓘ mark. The “Expert” menu mode adds to the “Basic” menu mode additional functions of the player that can be adjusted to further personalize performance of the player.

In this manual, functions that are contained in the “Expert” menu mode are identified by the Expert icon. Make changes to the [Setup Menu Mode] setting in the Setup screen **General** menu.

- 7** Use the cursor buttons (▲/▼) to select a new setting and press **ENTER** to set the new setting in memory. Press **RETURN** or the cursor button (◀) to exit the options without making any changes.
- 8** Press **RETURN** or the cursor button (◀) to go back to the main menu bar to select another menu.
- 9** Press **SETUP** to close the Setup screen. The Setup screen closes.

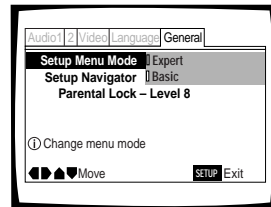

Settings: **Expert**
Basic*

* Factory setting

Note

On-screen information only appears in the “Basic” menu mode.

How to interpret the setting indicator colors in the Setup screen menus

When setting up the system, or when making adjustments, it is convenient to know what settings are applicable to the different disc formats. When the settings appear for each menu option, the currently selected setting appears with the setting indicator highlighted in one of three colors: blue, green or yellow. These colors correspond to what formats the menu option effects as shown in the table below.

Color of indicator	Disc format(s)
Blue	DVD only
Yellow	DVD / Video CD
Green	All compatible formats

Note

If a setting applicable only to DVDs is changed while a Video CD or CD is loaded, a blue DVD icon appears in the upper right hand corner of the screen to indicate that the setting is not applicable to the currently loaded disc. The setting will be effective the next time a DVD is loaded.

Setting the Digital Audio Output To Be Compatible with Your AV Component - DVD

This player is capable of digital audio output for Dolby Digital, DTS, MPEG, and signals with a sampling rate of 96 kHz. Make settings in the Setup screen **Audio 1** menu to reflect the capabilities of the components that you have made digital connections to.

Notes

- If you have already completed the Setup Navigator screen operations, the settings on this page have already been set by the player.
- If you have made only stereo line connections (analog) using the supplied audio cord, it is not necessary to make any changes in this menu.

Dolby Digital Out

This player is capable of outputting the Dolby Digital surround sound audio signal. When the player is connected to an AV component that has a built-in Dolby Digital decoder, select "Dolby Digital". This player can also convert the Dolby Digital signal to a digital Linear PCM signal, the same digital signal output from a CD. Select "Dolby Digital ► PCM" when you have made connections to an amplifier or receiver with a Dolby Pro Logic decoder or a Digital Analog Converter (DAC).

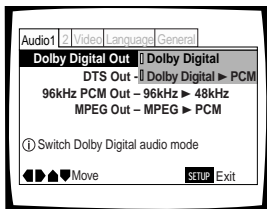

Settings: **Dolby Digital***
Dolby Digital ► PCM

*Factory setting

DTS Out

This player is capable of outputting DTS digital audio for DVDs recorded in DTS. When this player is connected to an AV component that has a built-in DTS decoder, select "DTS". If your system is not equipped to decode DTS, select "Off". Refer to the operating instructions supplied with your audio components if you are unsure about compatibility with DTS.

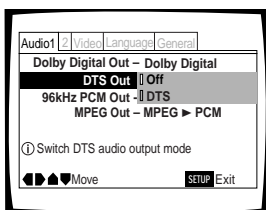

Settings: **Off***
DTS

* Factory Setting

Note

If you have made digital audio connections to component(s) not equipped to decode the DTS digital bitstream, be sure to select "Off". If a DTS signal is output without decoding, the output is digital noise that could potentially cause damage to your speakers.

96kHz PCM Out

This player is capable of outputting digital signals with a sampling frequency of 96 kHz. If you have made connections to a component capable of processing this signal rate, select "96 kHz" for the signal to be output as is. As some components are incapable of processing digital signal input with sampling rates of 96 kHz, selecting "96 kHz ► 48 kHz" compresses the signal to a standard signal with a sampling rate of 48 kHz.

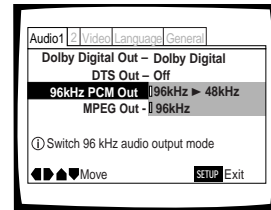

Settings: **96 kHz ► 48 kHz***
96 kHz

* Factory Setting

Note

On DVDs that contain copy protection, it may not be possible to play back the audio at 96 kHz. When this type of disc is encountered, even if "96 kHz" is selected, the player automatically outputs the audio at a compressed rate of 48 kHz.

MPEG Out

This player is capable of outputting the MPEG digital bitstream. When the player is connected to an AV component that has a built-in MPEG decoder, select the "MPEG" setting. Otherwise, select "MPEG ► PCM" to convert the digital signal to the PCM signal, the digital signal output from a CD.

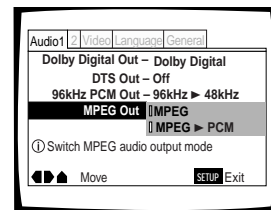

Settings: **MPEG**
MPEG ► PCM*

* Factory Setting

Setting Analog Audio Connections to an AV Amplifier or Receiver

This player is capable of both 2 channel stereo and 5.1 multichannel surround sound audio output. Use this setting to select which analog outputs are connected to an AV component.

Make adjustments in the [Audio Out] setting in the Setup screen **Audio 2** menu.

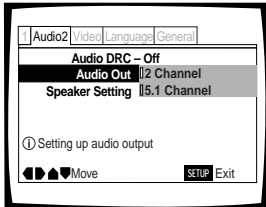

Settings: **2 Channel***
5.1 Channel

*Factory setting

Notes

- This setting can also be changed by using **5.1 CH MODE** on the front panel. However, this button does not work when the GUI indicator is lit.
- When "5.1 Channel" is selected, the front right (R) and front left (L) audio channels output from the AUDIO OUT (2 CH) jacks.
- If the center or surround components are not recorded on the disc, there will be no output from the CENTER or SURROUND output jacks. This is not a malfunction. Speaker channels can be verified in the multichannel indicators in the display.
- When "5.1 Channel" is selected at this setting and "Dolby Digital ► PCM" is selected in the [Dolby Digital Out] setting in the Setup screen **Audio 1** menu, there is no audio output from the digital output jacks.

Setting Your Speaker System for Multichannel Audio Playback

This player contains a built-in decoder for Dolby Digital audio sources as well as 5.1 channel discrete audio output that can be used to make connections to an amplifier or receiver with the corresponding inputs. Ideally, a 5.1 channel system contains 6 speakers: 2 front speakers, 2 surround speakers, a center speaker, and a sub woofer. However, as this is not always the case, accurately setting the [Speaker Setting] setting to reflect your speaker setup allows the player's built-in decoder to reroute signals to compensate for absent speakers.

Make adjustments in the [Speaker Setting] setting in the Setup screen **Audio 2** menu.

Notes

- If you have already completed the Setup Navigator screen operations, the settings on this page have already been set by the player.
- If you have not made connections to the 5.1 CH OUT jacks on the rear panel of the player, it is not necessary to make any changes to this setting.

1 Use the cursor buttons (◀▶) to select the speaker.

Every time the cursor button is pressed, the selected speaker changes in the following order.

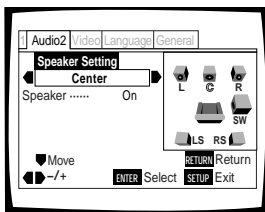
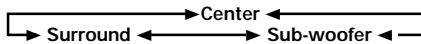

About source audio output

When the source input mode has been switched between the 5.1 CH and 2 CH mode settings using the [Audio Out] setting in the Setup screen **Audio 2** menu or by pressing 5.1 CH MODE on the front panel, audio output for each source will be as shown on the following table.

AUDIO CONTENTS	OUTPUT MODE	AUDIO OUT (2 CH)	AUDIO OUT (5.1 CH)				DIGITAL OUTPUT (S/PDIF)		
		L,R	Front L,R	Center	Surround L, R	Sub Woofer	Dolby digital ▶ PCM	Dolby Digital	
DVD	Dolby Digital	5.1 ch MODE	Front L ch, R ch	Front L ch, R ch	Center	Surround Lch Rch	LFE	MUTE	Dolby Digital
		2 ch MODE	2 ch DOWNMIX L ch, R ch	2 ch DOWNMIX L ch, R ch	MUTE	MUTE	MUTE	L ch, R ch	Dolby Digital
	Dolby Digital Karaoke	5.1 ch MODE	2 ch DOWNMIX L ch, R ch	2 ch DOWNMIX L ch, R ch	MUTE	MUTE	MUTE	MUTE	Dolby Digital
		2 ch MODE	2 ch DOWNMIX L ch, R ch	2 ch DOWNMIX L ch, R ch	MUTE	MUTE	MUTE	L ch, R ch	Dolby Digital
	LPCM	5.1 ch/2 ch MODE	L ch, R ch	Lch, Rch	MUTE	MUTE	MUTE	L ch, R ch	L ch, R ch
	MPEG	5.1 ch/2 ch MODE	L ch, R ch	Lch, Rch	MUTE	MUTE	MUTE	L ch, R ch	MPEG
DTS	5.1 ch/2 ch MODE	MUTE	MUTE	MUTE	MUTE	MUTE	MUTE	DTS	
CD	5.1 ch/2 ch MODE	L ch, R ch	L ch, R ch	MUTE	MUTE	MUTE	L ch, R ch	L ch, R ch	
Video CD	5.1 ch/2 ch MODE	L ch, R ch	L ch, R ch	MUTE	MUTE	MUTE	L ch, R ch	L ch, R ch	

2 Use the cursor button (▼) to move the cursor down to the speaker bar and use the cursor buttons (◀▶) to select "On" or "Off" corresponding to whether the selected speaker is present in your system or not, respectively.

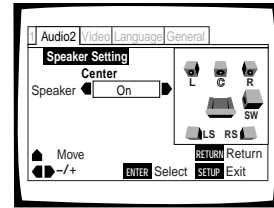

Notes

- To help identify the speakers being selected, the initials of the speakers in the speaker system representation on the right side of the screen will appear in blue.
- When "On" is selected for a speaker or pair of speakers, the icons for those speakers turn yellow in the speaker system representation on the right side of the screen.
- If "Off" is selected for both [Center Speaker] and [Surround Speaker], [Sub-woofer] is automatically set to "Off".
- When the sub woofer is "On", the low range components of the center and surround signals will be mixed in the LFE signal and output from the SUB WOOFER jack.
- When the sub woofer is "Off", the low range components of the center and surround signals will be mixed in the L and R signals and output from the front speakers.
- Speakers in this menu setting can also be turned on and off using **CENTER**, **SURROUND**, and **SUB WOOFER** on the front panel. However, these buttons do not work when the GUI indicator is lit.

Setting the TV Screen Size

The width-to-height ratio of conventional TVs is 4:3, while the width-to-height ratio of wide screen and high-definition TVs is 16:9. This width-to-height ratio is called the aspect ratio.

When viewing software recorded in different aspect ratios, the image's height to width ratio can be switched to match the TV or monitor being used.

Make changes to the TV screen size in the [TV Screen] setting in the Setup screen **Video** menu. Please note that changes to the [TV Screen] setting cannot be made when a disc is playing. Stop playback of the disc before attempting to make any changes.

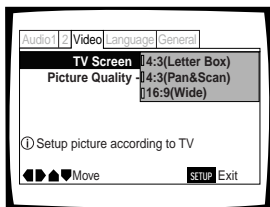

- Settings: **4:3 (Letter Box)**
4:3 (Pan & Scan)
16:9 (Wide)*

* Factory Setting



Notes





- If "Standard (4:3)" is selected in the Setup Navigator screen, "4:3 (Letter Box)" is selected on this screen. If you prefer the pan&scan format, change the settings on this screen.
- Whether the aspect can be switched or not depends on the disc. Please refer to the information written on the disc jacket, etc.
- Some discs may not include the screen format selected in the [TV Screen] setting. When this occurs, the standard TV screen format available on the disc is automatically selected.

Differences in screen sizes and DVD formats

The number of screen size formats currently available can be somewhat confusing. If set incorrectly, the video presentation may not appear as it should. The following diagrams and descriptions are intended to help you set your TV screen size in a way that will allow you to fully enjoy the digital video of DVD.

The settings in the [TV Screen] setting are perhaps most applicable when the DVD you are watching is programmed in the wide screen format. If you have a standard TV, select either "4:3 (Letter Box)" or "4:3 (Pan & Scan)" based on your personal preference. If you have a wide screen TV, select "16:9 (Wide)".

When viewing a wide screen TV or monitor	
DVD screen size format	Setting and Appearance
Wide screen format DVD Please note that there are some wide screen letter box formats that place black bars at the top and bottom of the screen. This is not a malfunction.	 <p>"Wide" setting</p>
Standard screen format DVD When viewing a standard screen format DVD on a wide screen TV, black bars may be automatically placed at the side of the screen to adjust to the DVD format.	 <p>"Wide" setting</p>
Standard screen format DVD (unnatural stretched effect) If you are viewing a standard screen format DVD on a wide screen TV, the picture may appear 'stretched' on the screen. To remedy this condition, change your wide screen TV to display a standard (4:3) screen. Refer to the instructions supplied with your wide screen TV or monitor for more information.	 <p>"Wide" setting</p>

When viewing a standard size TV or monitor	
DVD screen size format	Setting and Appearance
Wide screen format DVD The Letter box presentation places black bars at the top and bottom portions of the screen to provide the full wide screen presentation of a movie on a standard TV (4:3 aspect ratio).	 <p>"Letter Box" setting</p>
Wide screen format DVD The Pan & Scan presentation crops both sides of the wide screen presentation to use the full standard TV screen.	 <p>"Pan & Scan" setting</p>
Standard screen format DVD If you have a standard TV, the standard screen format will be presented regardless of the setting.	 <p>Any setting</p>
Wide screen format DVD (unnatural squeezed effect) If you are viewing a wide screen format DVD on a standard TV and the [TV Screen] setting is set to "Wide", the picture may appear 'squeezed' on the screen. To remedy this condition, select either "Letter Box" or "Pan & Scan".	 <p>"Wide" setting</p>

Adjusting the OSD (On-Screen Display)

If you have already completed the Setup Navigator screen operations, the settings on this page have already been set by the player.

Setting the on-screen display (OSD) language

This setting is used to establish the language that operation indicators and on-screen messages and operations display. Change this setting in the Setup screen **Language** menu [OSD Language] setting.



Settings: **English***
français
Español

* Factory Setting

Notes

- The languages that can be selected may be different from those shown above.
- The [OSD Language] setting is factory set to "English". If you want English to be displayed, it is not necessary to adjust this setting.

Turning the on-screen display on or off **Expert**

If you would rather not have the operation indicators (Play, Stop, Resume, etc.) and other messages displayed on the screen, it is possible to turn them off in the [On Screen Display] setting in the Setup screen **Video** menu in the "Expert" menu mode (page 29).

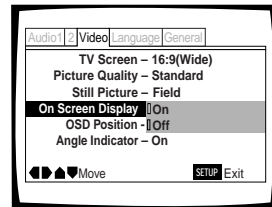

Settings: **On***
Off

* Factory Setting

Setting the position of the on-screen display **Expert**

When watching conventional software on a wide screen TV, the operation display is at the very top of the screen, and may be difficult to see. Changing the position of the display lets you see operation indicators clearly even on a wide screen TV.

Make changes in the [OSD Position] in the Setup screen **Video** menu in the "Expert" menu mode (page 29).

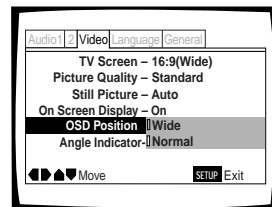

Settings: **Wide**
Normal*

* Factory Setting

Setting the Language Options

DVDs have the capacity to contain a great deal of audio information, which includes the ability to hold up to 8 different language tracks and subtitle information in as many as 32 different languages. This section outlines the variety of audio language and subtitle options available with this player.

Please note that if you have completed the Setup Navigator, the audio and subtitle language options have automatically been set in accordance with the OSD language (the language that appears on the screen).

In this section, you'll be able to:

- Select one of the subtitle languages programmed on a DVD or turn the subtitles off using the remote control (this page).
- Select one of the audio languages programmed on a DVD using the remote control (page 36).
- Change the audio output type when using Video CDs and CDs (page 36).
- Set preferences for audio and subtitle language (page 37).
- Set preferences for the language to be displayed by the DVD menu (page 38).
- Set Auto Language to display subtitles only for foreign films (page 39).
- Select whether to have the subtitles turned on or off, and even opt to select assist subtitles for viewers who are hard of hearing (page 39).
- Select the language of subtitles that appear even when the subtitles are turned off (page 39).

Note

DVDs differ in content and do not all contain multiple language or subtitle information. Therefore making settings in this section may have no effect on some DVDs.

Selecting a Subtitle Language (Multi-Language Subtitles)

– DVD

You can select a desired subtitle language with DVDs that have subtitle data in multiple languages recorded on them.

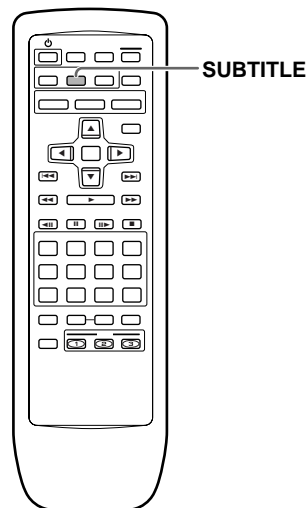
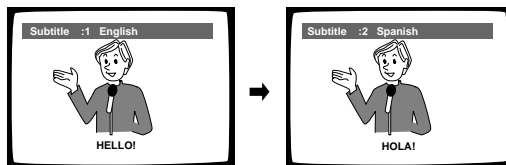

Press **SUBTITLE** repeatedly during playback.

Pressing **SUBTITLE** once displays the currently selected subtitle language. Subsequent presses rotate through the subtitle languages available on the DVD.

Notes

- The subtitle language cannot be switched if the subtitle language is not recorded, or if only one language is recorded.
- Switching the subtitle language may not be possible with some discs. In this case, the  mark will be displayed.
- To clear subtitles during playback, press **SUBTITLE** and then press **CLEAR**, or press **SUBTITLE** until "Off" appears.
- For some discs, subtitle language selection can be made using the menu on the DVD. In this case, press **MENU** to display the DVD menu screen and then make your selection.

Changing the Audio Language (Multi-Language Function) – DVD

Dolby Digital, PCM, and other audio data can be recorded on DVDs in a number of languages or audio tracks, letting you choose the desired language or audio.

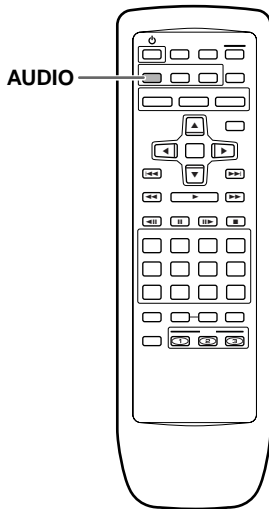
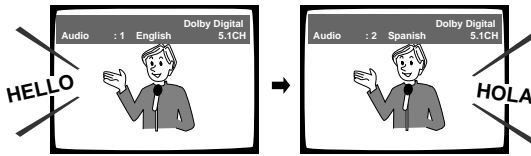

Press **AUDIO** repeatedly to select the desired language.

Pressing **AUDIO** once displays the currently selected language. Subsequent presses rotate through the audio languages available on the DVD.

Notes

- You cannot switch languages if there is only one language recorded on the disc.
- Switching the audio language may not be possible with some titles. In this case, the  mark is displayed.
- For some titles, selection can be made using the DVD menu. In these cases, press **MENU** to display the DVD menu screen and then make your selection.

Changing Audio Type – Video CD/CD

For enjoyment of karaoke or similar format Video CDs and CDs, it is possible to select stereo audio, or either right or left channel mono depending on the requirements of the source.

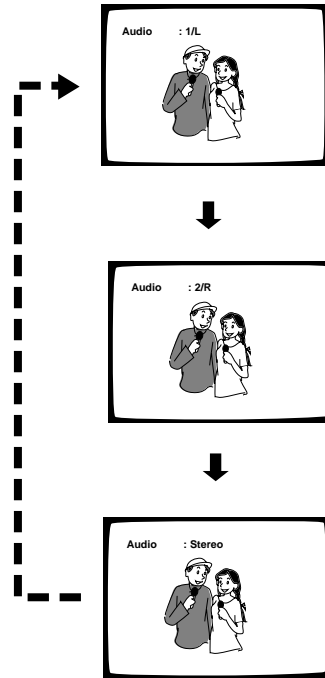

Press **AUDIO** repeatedly during playback to switch the audio type.

Audio output changes from "1/L" (Left channel) to "2/R" (Right channel) to "Stereo".

Note

With karaoke and other discs, set the appropriate audio type for singing and accompaniment after referring to information on the disc jacket or accompanying material.

Setting Language and Subtitle Preferences in the Setup Screen Menus

The Setup screen **Language** menu contains a number of settings related to the audio and subtitle language preferences.

Please note that changes to the settings in the **Language** menu in this section cannot be made when a disc is playing. Stop playback of the disc before attempting to make any changes.

Selecting an audio language preference

The audio language that you normally listen to can be selected from the various audio languages on a DVD. Even when the audio language is changed during playback by pressing **AUDIO**, the language selected at this setting will be selected as the default when the DVD is changed.

Make changes to the [Audio Language] setting in the Setup screen **Language** menu.



Settings: **English***

French

Spanish

Other (For details on how to select other languages, see 'When "Other" is selected' on the following page.)

*Factory setting

Selecting a subtitle language preference

The subtitle language that you will normally display can be selected from the subtitles programmed on a disc. Even when the subtitle language is changed during playback by pressing **SUBTITLE**, the language selected at this setting will be selected when the disc is changed.

Make changes to the [Subtitle Language] setting in the Setup screen **Language** menu.

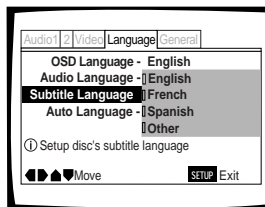

Settings: **English***

French

Spanish

Other (For details on how to select other languages, see 'When "Other" is selected' on the following page.)

*Factory setting

When "Other" is selected

When you want to select one of the 136 languages as the main audio language, follow the steps below when the following screen appears.

A language code list can be found on page 57.

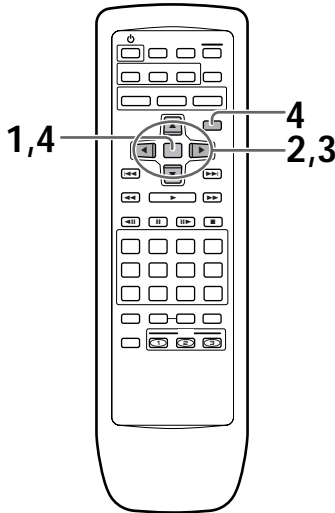
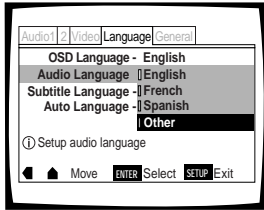

- 1 Use the cursor buttons to select "Other" and press **ENTER**.
The language selection screen appears.

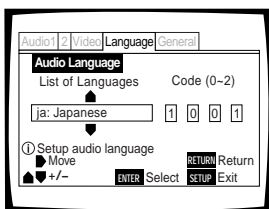

- 2 Use the cursor buttons (◀/▶) to select either "List of Languages" or "Code".
- 3 If you select "List of Languages", use the cursor buttons (▲/▼) to select the language.

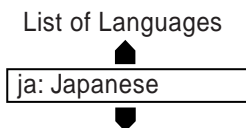

If you select "Code", use the number buttons to enter the code. You can also use the cursor buttons (▲/▼) to input the code number. Use the cursor buttons (◀/▶) to change the position of the cursor.

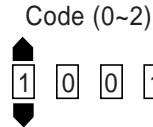

- 4 Press **ENTER** to set the new language.
To exit the screen without making any changes, press **RETURN**.

Selecting a DVD menu language preference Expert

In addition to containing different audio languages, DVD may also contain menu screens in different languages as well. Setting a DVD language preference, sets the selected language as a default when DVDs with menu information in that language are encountered.

Selecting "w/ Subtitle Language" automatically assigns the language selected in the [Subtitle Language] setting.

Make changes to the [DVD Language] setting in the Setup screen **Language** menu in the "Expert" menu mode (page 29).



Setting: **w/ Subtitle Language***

English
French
Spanish
Other

* Factory setting

Notes

- The menu settings may look different from the one shown above.
- If may also be possible to select a DVD language from the disc's own menu. Press **MENU** to open the DVD menu and make your selection accordingly.

Setting Auto Language to control subtitle and audio language based on program content

When the Auto Language function is used, foreign movies are shown with the original audio soundtrack and subtitles in the language selected in the [Subtitle Language] menu option. Domestic films are shown with the original audio soundtrack and no subtitles.

Make changes to the [Auto Language] setting in the Setup screen **Language** menu.



Settings: **On***
Off

* Factory setting

Note

The Auto Language function operates only when this function is set to "On", and the languages set for the [Audio Language] and [Subtitle Language] settings are the same.

Selecting subtitles, assist subtitles or no subtitles Expert

Use this function to turn the subtitles on or off. Also, some DVDs provide assist subtitles that give additional explanations of scenes in addition to the standard subtitles for viewers who are hard of hearing. Select "Assist Subtitle" to display these subtitles on DVDs where this function is offered.

Make changes to the [Subtitle Display] setting in the Setup screen **Language** menu in the "Expert" menu mode (page 29).

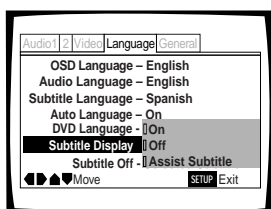

Settings: **On***
Off
Assist Subtitle

* Factory setting

Notes

- If there is no subtitle information recorded on the DVD, no subtitles are displayed even if this function is set to "On".
- This setting serves as a default as whether or not to display subtitles. Even if this option is set to "Off", subtitles can be displayed by pressing **SUBTITLE**. Similarly, if this option is set to "On", the subtitles can be turned off by pressing **SUBTITLE** and then **CLEAR**.

Selecting the language of forced subtitles Expert

Even when the subtitles are turned off, some DVDs will nevertheless display them on the screen. This setting allows you to select the language of the subtitles to be displayed with this type of DVD.

Select "With Audio" to display the subtitles in the same language as the currently selected audio language. Select "Selected Subtitle" to display the subtitles in the language set in the [Subtitle Language] setting.

Make changes to the [Subtitle Off] setting in the Setup screen **Language** menu in the "Expert" menu mode (page 29).

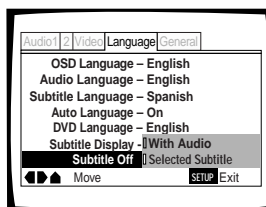

Settings: **With Audio**
Selected Subtitle*

* Factory setting

Advanced Functions

This player is compatible with DVD, Video CD, and CD disc formats. Users already familiar with Video CD or CD will already be familiar with some of the functions the player is capable of performing. With DVD, an even greater number of possibilities and functions are available.

In this section, you'll be able to:

- **Set the dynamic range of the audio soundtrack so that quiet sounds can be heard better (this page).**
- **Adjust the picture quality to better match program content (this page).**
- **Pause DVD or Video CD playback, play at extremely slow speeds or view frame by frame (page 41).**
- **Search for titles, chapters, tracks or locations on a disc (page 42).**
- **Change the angle of playback when viewing DVDs with multi-angle programming (page 43).**
- **Repeat chapters or titles on DVDs, or repeat tracks, 1 disc, or all discs (ALL) with CDs and Video CDs. You can also repeat just a specified part of a chapter or track (page 44).**
- **Play DVD titles or chapters, Video CD/CD tracks, 1 disc or all discs (ALL) in random order (page 45).**
- **Program DVD titles or chapters, or Video CD/CD tracks to play back in a specified order (page 46).**
- **Set the parental lock level to prevent children from having access to inappropriate material (page 48).**
- **Continue watching a DVD from where you left off using the Last Memory function (page 50).**
- **Save the system settings for up to 15 DVDs with the Condition Memory function (page 51).**
- **View playing time and other disc information (page 53).**
- **Change the background color (page 54).**
- **Turn the screen saver on and off (page 54).**
- **Reset the system (page 54).**

Note

DVDs differ in content and do not all contain the same information. Therefore some functions in this section may not work or have no effect on some DVDs.

Adjusting the Dynamic Range of the Audio Soundtrack – DVD

Audio DRC stands for Audio Dynamic Range Compression. When Audio DRC is on, soft sounds such as dialog can be heard more clearly without making loud sounds even louder. Select from three levels of compression depending on how much effect you want. When Audio DRC is set to "Off", there is no effect on the audio source.

Make changes to the [Audio DRC] setting in the Setup screen **Audio 2** menu.

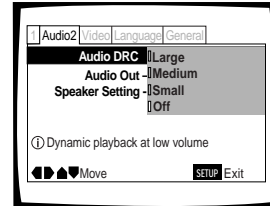

- Settings:
- Large**
(maximum compression of audio source)
 - Medium**
(moderate compression of audio source)
 - Small**
(very little compression of audio source)
 - Off***

* Factory setting

Note

Audio DRC is only effective with Dolby Digital audio sources.

Selecting Picture Quality Appropriate for Program Content – DVD/Video CD

This lets you select the ideal picture quality for watching movies, animation and other video media.

Make changes to the [Picture Quality] setting in the Setup screen **Video** menu.

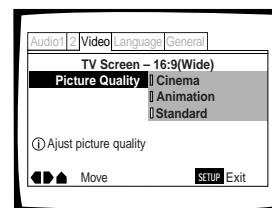

- Settings:
- Cinema**
Provides a sharp, clear black picture for images with high contrast.
 - Animation**
Provides images with bright clear colors.
 - Standard***
Presents the video with no effect added.

* Factory setting

Still Frame/Slow Play/Frame Advance Playback – DVD/Video CD

The video images on DVD and Video CD can be viewed as a still frame, played back at slow speeds and even advanced frame by frame.

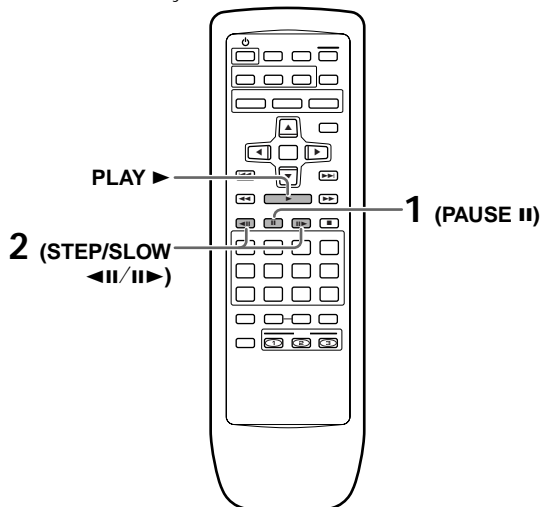

Viewing a still frame

Press **PAUSE II**.

When viewing a DVD, if the paused picture shakes, select the "Field" setting in the Setup screen **Video** menu [Still Picture] setting as described in the section below.

To return to normal playback

When viewing a still frame playback, pressing **PAUSE II** or **PLAY ►** restores normal playback operation.

Selecting the type of paused image to display Expert

This function lets you view a clear still-image when DVD playback is paused.

Make changes in the [Still Picture] setting in the Setup screen **Video** menu in the "Expert" menu mode (page 29).

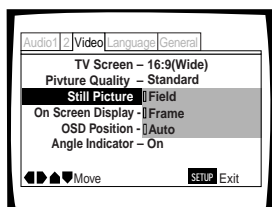

Settings: **Field** (Picture shake will be eliminated during a paused picture.)

Frame (Select to obtain higher picture quality.)

Auto* (Selects field or frame automatically according to the disc.)

* Factory setting

Viewing slow playback

Press and hold **STEP/SLOW II►** for about 2 seconds during playback.

- Slow playback is engaged.
- During slow playback, the speed of playback can be adjusted from 1/2 normal playback speed to 1/16 normal playback speed in four steps using **STEP/SLOW ◀II and II►**.

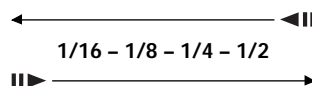

Press and hold **STEP/SLOW ◀II** during DVD playback.

- Slow playback in the reverse direction is engaged.
- In the reverse direction, the playback speed cannot be adjusted.

To return to normal playback

When viewing still frames or slow playback, pressing **PLAY ►** restores normal playback operation.

Frame by frame advance playback: Viewing one frame at a time

1 Press **PAUSE II**.

2 Press **STEP/SLOW ◀II or II►**.

STEP/SLOW II►: The picture advances one frame each time the button is pressed.

STEP/SLOW ◀II: For DVDs only, the picture backs up a few frames each time the button is pressed.

To return to normal playback

When viewing frame by frame playback, pressing **PLAY ►** restores normal playback operation.

Notes

- There is no sound when viewing still frames or slow playback, or when advancing one frame at a time.
- Still frame, slow play, or frame advance playback may not be possible with certain titles. In this case, the mark is displayed.

Searching for a Title, Chapter, Track, or Location on a Disc

– DVD/Video CD/CD

This player offers different ways of accessing the information on a DVD, Video CD, or CD. Using **SEARCH MODE**, you can search for titles or chapters on a DVD, tracks on a Video CD or CD, and even select the point in time to start playback.

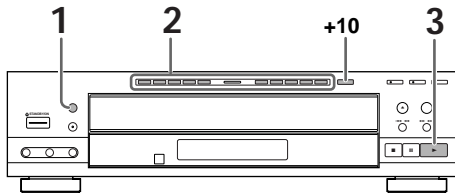
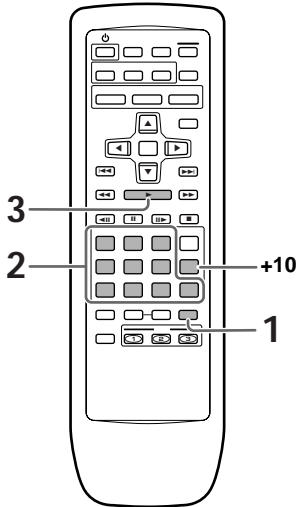

- 1 Press **SEARCH MODE** repeatedly to select the type of search.

The type of search changes with each press as follows.

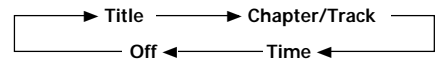

- 2 Press the number button(s) of the desired title, chapter/track or of the specific time where you would like to begin playback.

- To select number 3, press 3.
- To select number 10, press 1 then 0
- To select number 37, press 3 then 7.

When performing a time search:

- To select 21 minutes, 43 seconds, press 2, 1, 4, then 3.
- To select 1 hour, 14 minutes, press 7, 4, 0, then 0.

- 3 Press **PLAY** ► (► on the front panel). Playback of the selected title, chapter or track starts. When a time search is performed, playback begins at the appointed time.

To perform a direct title or chapter/track search using the number buttons

Press the number buttons while the disc is stopped to select a title or track number.

Press the number buttons while the disc is playing to select a chapter or track.

- To select number 3, press 3.
- To select number 10, press +10 then 0
- To select number 37, press +10, +10, +10 then 7.

Notes

- For some discs, selection can be made using the top menu on the DVD. In this case, press **TOP MENU** to display the menu screen and then make your selection.
- With some DVDs, the search operation may not be possible and may stop shortly after being performed. In this case, the  mark is displayed.
- Time search is not possible with CDs.
- When performing DVD time search, playback may start from a slightly different time than that specified.
- Time search is not possible during when the disc is stopped.
- Search using **SEARCH MODE** does not work during PBC playback of Video CDs.

Viewing from a Desired Camera Angle (Multi-Angle)

- DVD

You can select a camera angle when viewing DVDs with the multi-angle option.

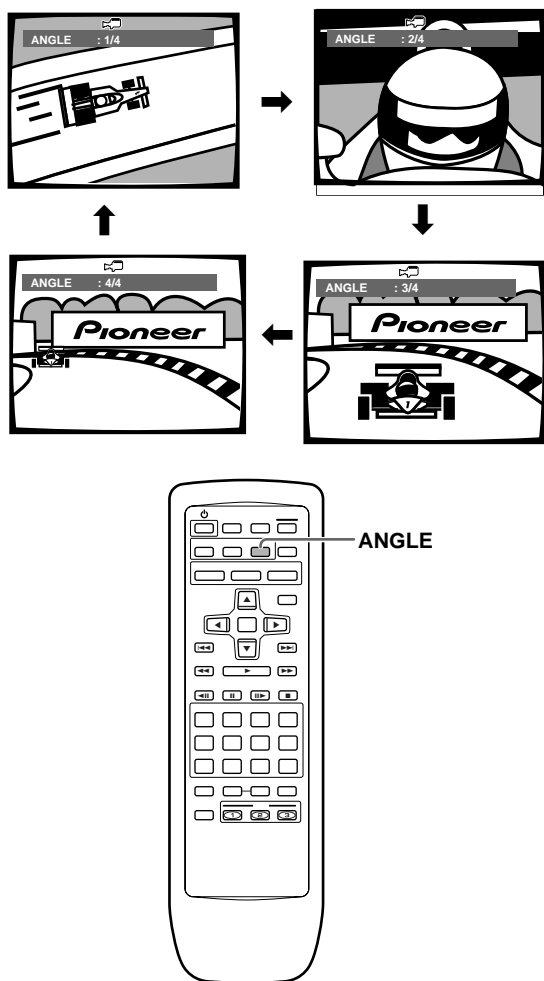

Press **ANGLE** during playback.

The camera angle changes each time you press the button.

Notes

- You can use the Multi-Angle function only with discs featuring recordings of images shot from different camera angles.
- During Multi-Angle playback, the ANGLE indicator in the display lights.
- For some discs, selection can be made using the DVD menu. In this case, press **MENU** to display the DVD menu screen and then make your selection.

To check whether or not a disc is recorded with angles:

The jacket of discs that are recorded with angles will be marked with . When locations on discs that are recorded with angles are played back, the indicator can be displayed.

To cancel the indicator, set [Angle Indicator] to "Off" in the Setup screen **Video** menu described in the section below.

Turning the angle indicator on and off

When a picture recorded in different angles is played back the indicator is displayed on the screen. This setting lets you see clearly whether the playback picture is recorded in multiple angles or not.

Turn the angle indicator on or off in the [Angle Indicator] setting in the Setup screen **Video** menu in the "Expert" menu mode (page 29).

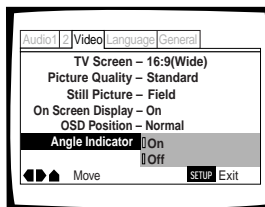

Settings: **On*** (is displayed)

Off (Not displayed)

* Factory setting

Note

Even when the [Angle Indicator] setting is set to "Off", the ANGLE indicator in the display panel of the player lights during multi-angle playback. Therefore, it is possible to know when the multi-angle function can be used without having to display the icon on the screen.

Repeat Play – DVD/Video CD/CD

You can repeat chapters or titles on DVDs, or repeat tracks, one disc or all discs (ALL) with CDs and Video CDs. You can also repeat just a specified part of a chapter or track.

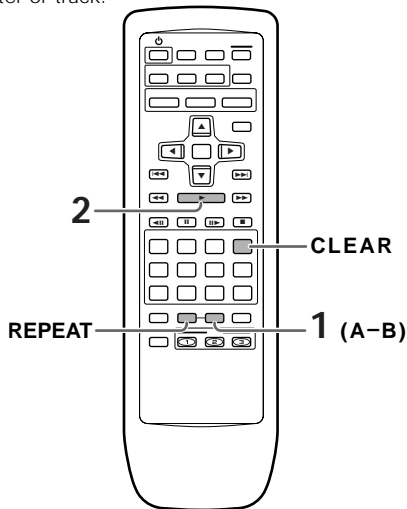

Repeat play options for a DVD

Press **REPEAT** once during playback of the chapter you want to repeat, and twice to repeat playback of the current title. Each time **REPEAT** is pressed, the repeat mode changes as follows.

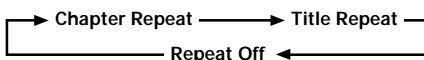

- During repeat title playback, the title continues playing until the end, and then playback starts once more from the beginning of that title.

Repeat play options for a Video CD or CD

Press **REPEAT** once during playback of a track you want to repeat, twice to repeat playback of the current disc, and three times to repeat all of the discs loaded in the player. Each time **REPEAT** is pressed, the repeat mode changes as follows.

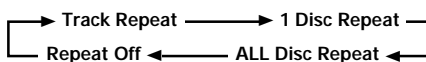

- During ALL disc repeat playback, if a DVD is loaded in the player, repeat playback is canceled, and normal playback of the DVD begins.

To repeat a program

Press **REPEAT** once during program playback to repeat the program (page 47).

To cancel repeat play

Press **CLEAR**. Playback continues, but the repeat function is canceled.

Repeat play of a specified section

Press **A-B** at the beginning and end of the section you want to repeat.

- When **A-B** is pressed a second time, the disc returns to the location where **A-B** was pressed first and plays the selected section repeatedly.
- You can only perform A-B repeat within the same title.

To cancel A-B repeat play

Press **CLEAR**. Playback continues, but the repeat function is canceled.

Return to a specified location on a disc

- 1 Press **A-B** at the desired location.
- 2 When you want to return to the specified location, press **PLAY** ►.

To clear the specified location

Press **CLEAR** to cancel repeat play or to clear the specified location that was set using **A-B**.

Notes

- With some DVD discs, there may be times when repeat playback is not possible. In these cases, the  mark will appear on the screen.
- With Video CDs, repeat play is not possible when the menu is displayed (PBC playback). To perform repeat play, start playback without displaying a menu by pressing the track number to be repeated when the disc is stopped, and then press **REPEAT**.

Random Play – DVD/Video CD/CD

You can play in random order chapters or titles on DVDs, or tracks, 1 disc, or all discs (ALL) with CDs and Video CDs.

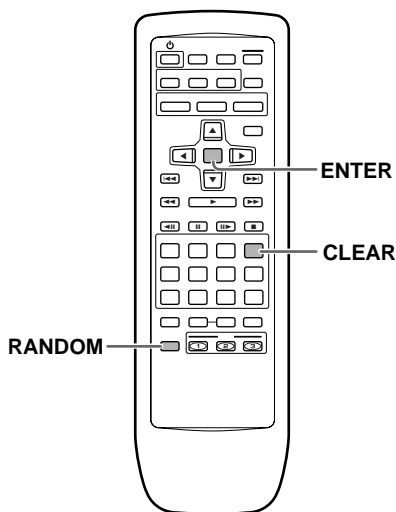

Random playback of chapters within one title – DVD

Press **RANDOM** once, then press **ENTER**.

“Random Chapter” appears on the screen, and chapters within the title will be played back in random order.

Random playback of titles–DVD

Press **RANDOM** twice, then press **ENTER**.

“Random Title” appears on the screen, and titles will be played back in random order.

Random playback of all tracks on a disc

–Video CD/CD

Press **RANDOM** once, then press **ENTER**.

“Random Track” appears on the screen, and random playback begins.

Random playback of all tracks on all discs

–Video CD/CD

Press **RANDOM** twice, then press **ENTER**.

“Random All” appears on the screen, and random playback begins.

All tracks on all CDs and Video CDs loaded will play in a random order (DVD discs loaded will be ignored).

To change titles, chapters, or tracks during random play

- Press **NEXT** ►► and the next randomly selected track starts playing.
- Press **PREVIOUS** ◀◀ and playback of the current track starts again from the beginning.

To stop random play

Press **CLEAR**. This returns you to normal playback of chapters/tracks in order from the chapter/track currently playing.

Notes

- With Video CDs, random play is not possible during playback when the menu is displayed (PBC playback). To perform random play, start playback without displaying a menu by pressing a track number button while in the stop mode, and then press **RANDOM**.
- In the case of DVDs, random playback may not be possible with some discs.

Playback in a Desired Order (Program Play) – DVD/Video CD/CD

The titles and chapters on a DVD and similarly the tracks on a Video CD or CD can be arranged to play in the order you want. You can create a program mixing titles, chapters, and tracks on all of the discs loaded in the disc tray.

Programming

A program with a maximum of 24 steps can be memorized from any of discs loaded in this player.

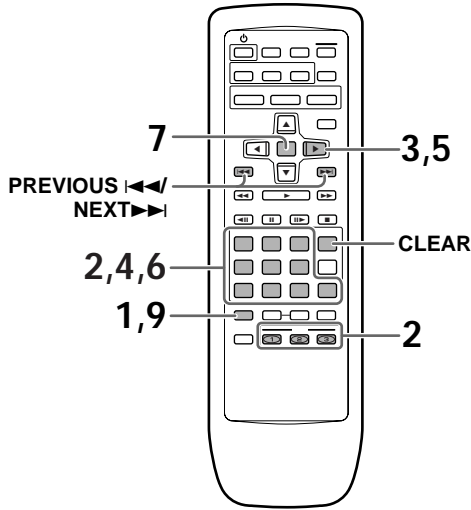

1 Press **PROGRAM**.

The Program screen appears.

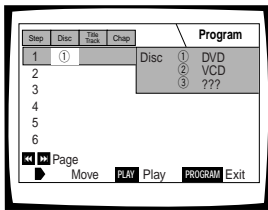

2 Use the number buttons or **DISC** (1 through 3) to enter a disc number.

- If this is the first step you are programming, the number of the disc that is currently in the play position will appear automatically.
- If the player has already read the contents of the disc you want to program, the disc information appears in the box on the right side of the screen (type of disc, number of titles/chapters/tracks, etc.). If the player has not yet read the disc then "???" appears in the box for disc type.
- If you want to program the entire selected disc, proceed to step 7.

3 Use the cursor buttons (▶) to select the Title/Track field.

4 Use the number buttons to enter the numbers of the title or tracks in the order you want to program them in.

- For DVDs, this number will be a disc title; for Video CDs and CDs, a track number.
- To enter title/track 6, press 6. To enter title/track 14, press 1, 4.

(Example)

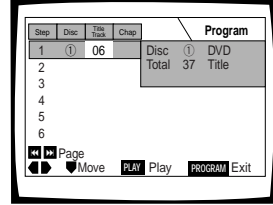

Notes

- If the current disc is a DVD, and you want to program chapters, proceed to the next step.
- If the current disc is a Video CD or CD, or if you want to program entire titles on a DVD, proceed to step 7.

5 Use the cursor buttons (▶) to select the Chapter field.

6 Use the number buttons to enter the numbers of the chapter in the order you want to program them in.

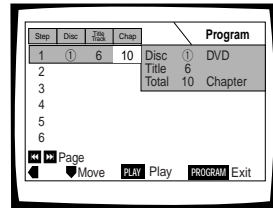

7 Press **ENTER**.

- The cursor moves down to the disc number field in the next step set.

8 Repeat steps 2-7.

9 Press **PLAY** ▶ to start playback in the programmed order.

- Press **PROGRAM** to exit the program screen.
- The program remains active even if you open the disc tray and change discs. If a step in the program cannot be played (because the track number is too high, for example), that step is automatically skipped.

To confirm the contents of a program

- 1 Press **PROGRAM**.
- 2 Use the **◀◀/▶▶** buttons to jump to the next/previous page of six steps (**◀◀/▶▶** on the front panel cannot be used to perform this operation).
- 3 Press **PROGRAM** to exit the program screen.

To change the contents of a program

- 1 Press **PROGRAM**.
- 2 Jump to the page of steps with the contents you want to change using the **◀◀/▶▶** buttons (**◀◀/▶▶** on the front panel cannot be used to perform this operation).
- 3 Use the cursor buttons (**▲/▼**) to select the step you want to change.
- 4 Move the cursor to the appropriate field using the cursor buttons (**◀/▶**).
- 5 Press the number button(s) of the number you want to change.
- 6 Press **PROGRAM** to exit the program screen.

To add to a program

Add a new Disc, Title/Track or Chapter at the end of the program by following the steps in the section "Programming" on the previous page.

To repeat the contents of a program

During program playback, press **REPEAT**. The entire program will be repeated.

To delete a step in a program

- 1 Press **PROGRAM**.
- 2 Jump to the page with the contents you want to delete using the **◀◀/▶▶** buttons (**◀◀/▶▶** on the front panel cannot be used to perform this operation).
- 3 Use the cursor buttons (**▲/▼**) to select the step you want to delete.
- 4 Press **CLEAR**.
- 5 Press **PROGRAM** to exit the program screen.

To clear the entire program

Pressing **CLEAR** when the disc is stopped will clear all program data.

To stop program play

Press **STOP** ■.

Notes

- If a chapter is programmed for a disc that has not yet been read by the player ("???" is displayed), and a CD or Video CD is later detected in the tray, the chapter program information is cleared. Additionally, if there is no disc in the tray, or if the programmed chapter number is larger than the number of chapters in the selected title, the chapter program information is erased.
- During DVD playback, when a chapter that cannot be played as part of program playback is encountered, **■** or **■** is displayed, and the program automatically proceeds to the next chapter.
- Programming is not possible during PBC playback of Video CDs. To program Video CDs, stop playback before attempting to make a program.
- During programmed playback, if the disc changer is rotated to play a DVD, an asterisk may be displayed in the upper right corner of the screen. This is to indicate that there is information on the disc that must be played first (First Play PGC). Depending on the disc, the asterisk may blink continuously during playback of chapters that were not programmed and then disappear shortly before playback of the desired location on the disc.

Setting the Parental Lock Level

This player lets you set the Parental Lock if the DVD has a parental lock level recorded on it. With Parental Lock capable discs, you can block access to material you feel is inappropriate for your children. Refer to the DVD disc jacket and the accompanying documentation to see if a particular disc contains a parental lock level.

Make changes to the [Parental Lock] setting in the Setup screen **General** menu. Please note that changes to the Parental Lock level cannot be made when a disc is playing. Stop playback of the disc before attempting to make any changes.

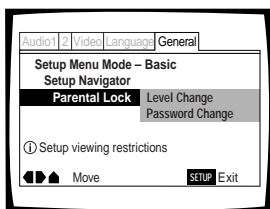

Settings: **Level Change** (For information, refer to 'Setting the Parental Lock level' on the following page.)

Password Change (For information, refer to 'Changing the password' on the following page.)

When a DVD with a set Parental Lock level is loaded

Playback cannot be started until the password has been correctly input by using the cursor buttons (◀/▶/▲/▼) or the number buttons, and **ENTER** has been pressed.

Entering the password

When you select either "Level Change" or "Password Change", it is necessary to enter the password (4-digit code number). Use the following steps at any time you are asked to enter or confirm your password.

- 1 Use the cursor buttons (▲/▼) or the number buttons to select a number between 0 and 9. You can also use the number buttons to enter the numbers directly. When entering your password for the first time, or changing it, you will be asked to reenter your password. When using the number buttons to confirm the password, the numbers appear as asterisks, and the cursor advances automatically to the next position.

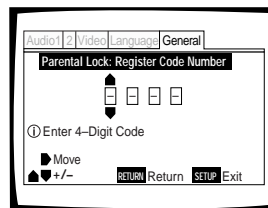

- 2 Use the cursor buttons (◀/▶) to move the cursor to a different position in the password. When all four numbers of the password have been entered, **ENTER** appears on the screen.

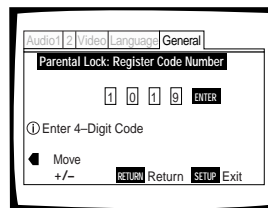

- 3 Press **ENTER** to set the new password. The password is entered.

Note

Be sure not to forget your password. If you should forget it, reset the system, and enter a new password. To reset the system, see 'Resetting the Player to System Settings' (page 55). Please note that this procedure resets the system, and clears all saved settings, not just the password.

Setting the Parental Lock level

Change the Parental Lock level to a higher or lower level according to the settings printed on the DVD disc jacket or accompanying documentation. If you use the Condition Memory function to save the settings for a particular disc, the Parental Lock level is saved as well. Because it is saved in memory, Parental Lock levels can be set for individual discs according to their content rather than a set level for all DVDs.

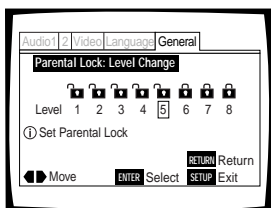

- 1 Select "Level Change" in the [Parental Lock] setting and press **ENTER**.

The screen changes to the password input screen. If you have not yet set a password, you will be asked to do so at this time. To enter the password, refer to 'Entering the password' on the previous page.

- 2 Use the cursor buttons (◀/▶) to adjust the Parental Lock level.

The lock icons appear "unlocked" up to the selected level to indicate that access is available.

- 3 Press **ENTER** to set the new level.

The new Parental Lock level is set and the screen returns to the **General** menu screen. To go back to the **General** menu screen without making any changes, press **RETURN**.

Changing the password

Change your password whenever you feel it is necessary. However, if you forget your existing password, you cannot enter this screen to change it.

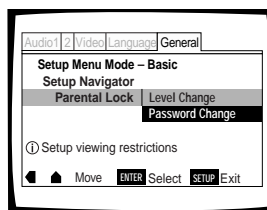

- 1 Select "Password Change" in the [Parental Lock] setting and press **ENTER**.

The screen changes to the password input screen as shown in the section 'Entering the password' on the previous page.

- 2 Enter your current password.

To enter the password, refer to 'Entering the password' on the previous page.

If you have not yet set a password, you cannot select this setting. Establish a password by selecting "Level Change" first.

- 3 Use the cursor buttons (◀/▶/▲/▼) or the number buttons to enter the new password.

- 4 When the new password has been entered, press **ENTER**.

The new password is set and the screen returns to the **General** menu screen. To go back to the **General** menu screen without making any changes, press **RETURN**.

Continuing Playback from a Specified Location (Last Memory) – DVD/Video CD

The Last Memory function is convenient when you want to continue viewing a disc from the point where you were watching before. Unlike the resume function, the Last Memory function is effective even if the DVD is removed from the player (With Video CDs, the LAST MEMORY location is erased from memory when the disc is changed or ejected.)

Memorizing a Last Memory location to return to later

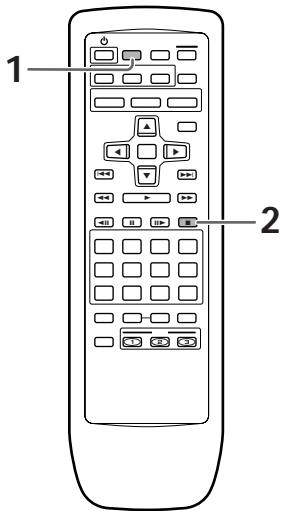

1 Press **LAST MEMORY** during playback. The LAST MEMORY indicator lights in the display window.

2 Press **⏻** to turn the power to standby, or stop playback with **STOP ■**.

Once memorized, the memorized point on a DVD will be recalled even if the power is turned off, or if the disc is ejected. Points on up to five DVDs can be memorized, and those points are recalled the next time they are played back.

- With Video CDs, the location in playback where LAST MEMORY was pressed is cleared when the disc is changed or ejected.

Resuming playback from where LAST MEMORY was pressed

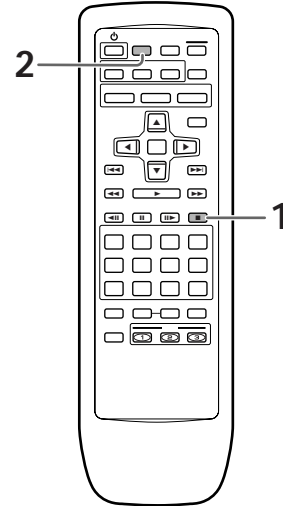

1 Load the DVD that has a Last Memory point memorized. Some DVDs will start playback automatically when loaded. In this case, press **STOP ■** to stop playback.

- When a Last Memory location is registered for a Video CD, the location is cleared when the disc is changed or ejected.

2 Press **LAST MEMORY** while in the stop mode. The disc begins playback at the memorized point.

- Last Memory mode may not function for some DVDs.
- If you register more than five DVDs, details of the latest disc are memorized, while details of the least recent disc (the disc you registered first) is erased.
- Even with a disc you have memorized with Last Memory, playback begins at the start of the disc if you press **PLAY ►**.
- This function is possible for DVDs and Video CDs only, and cannot be used with CDs.

To clear the Last Memory location

Press **LAST MEMORY**, then **CLEAR** while "Last Memory" is still being displayed on the screen.

The LAST MEMORY indicator disappears from the display window.

Memorizing Settings for Often Viewed DVDs (Condition Memory) – DVD

You can store in memory settings for DVDs you often watch. Settings remain in memory even if you remove the disc from the player, or switch power to the player to standby. If you load a disc that has its settings memorized, “COND_MEMO” appears in the display. When you start playing the disc, the memorized settings are automatically recalled.

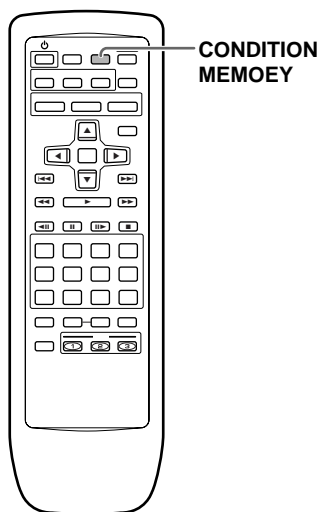

When a disc that has memorized settings is loaded

“Condition Memory” will appear on the screen, and the previously memorized settings will be selected.

Erasing the memorized settings

Press **CONDITION MEMORY**, then **CLEAR** while “Condition Memory” is still being displayed on the screen. The **CONDITION MEMORY** indicator disappears from the display window.

Notes

- Settings are stored in memory for use any time.
- You can store settings for up to 15 DVDs in memory. If you memorize settings for more than 15 DVDs, previously memorized settings are erased in chronological order from the least recently memorized. Subsequently, if you load a disc with erased settings, the settings of the most recently played disc are used.
- If you make changes to any of the settings memorized in Condition Memory, press **CONDITION MEMORY** during playback to memorize new settings.
- Switching of the multi-language mode etc., is automatic on some discs.

Press **CONDITION MEMORY** during playback.

Settings are memorized for the disc currently playing.

The following six settings are memorized:

OSD Position (page 34)

Multi-Language subtitles (page 35)

Multi-Language (page 36)

Picture Quality (page 40)

Multi-Angle (page 43)

Parental Lock Level (page 48)

Viewing Disc Information

- DVD/Video CD/CD

Use **DISPLAY** to get current information about the disc currently loaded. You can get information about the titles and chapters on a DVD or tracks on a Video CD or CD. When viewing DVDs, you can also check the digital bitstream transmission rate.

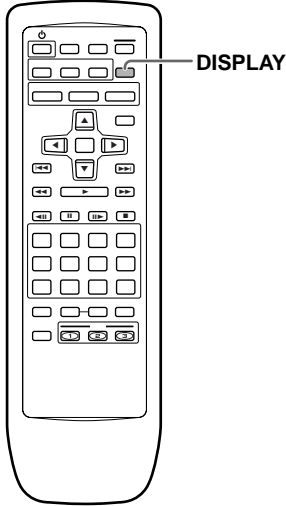

Press **DISPLAY** while a disc is playing. Press **DISPLAY** repeatedly to change the information being displayed.

The disc information is displayed superimposed over the video image on the screen.

Note

- Depending on the format and type of disc being used, not all screens may be displayed.
- When the Angle indicator is being displayed during playback of DVDs that contain multi-angle information, the disc number is hidden by the angle mark.

The display changes for each type of disc as follows each time the button is pressed.

DVD



TITLE information:

Top Row: disc number, title and chapter number, elapsed time of current title

Bottom Row: remaining time in current title, total time of current title



CHAPTER information:

Top Row: disc number, title and chapter number, elapsed time of current title

Bottom Row: time in current chapter, total time of current chapter



CHAPTER information:

Top Row: disc number, title and chapter number, elapsed time of current title

Bottom Row: remaining time in current chapter, total time of current chapter

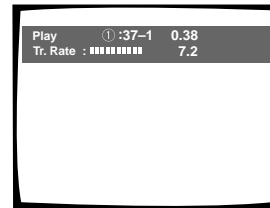

Data transmission rate information:

Top Row: disc number, title and chapter number, total elapsed time of DVD

Bottom Row: bitstream transmission rate level



Display off

CD



Track Information:

Top Row: disc number, track number, track time

Bottom Row: remaining time of current track, and total time of current track

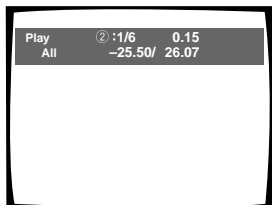

Disc information:

Top Row: disc number, track number, total number of tracks on CD, total elapsed time of CD

Bottom Row: remaining time of CD, total time of CD



Display off

Video CD (with PBC disabled)



Disc information:

Top Row: disc number, track number, total number of tracks, total elapsed time of Video CD

Bottom Row: remaining time of Video CD, total time of Video CD

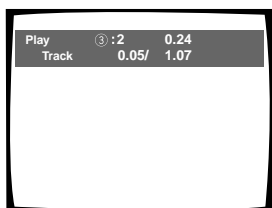

Track information:

Top Row: disc number, track number, total elapsed time of Video CD

Bottom Row: track time, total time of current track

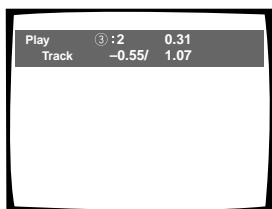

Track information:

Top Row: disc number, track number, total elapsed time of Video CD

Bottom Row: remaining time of track, total time of current track



Display off

Press **DISPLAY** during while a disc is stopped to display DVD title and chapter information or Video CD and CD track information. Press **DISPLAY** again to turn the display off.

Information about the titles and chapters or tracks on a disc is displayed. When the information exceeds the space on the screen, use the cursor buttons (◀▶) to move to other screens.

DVD

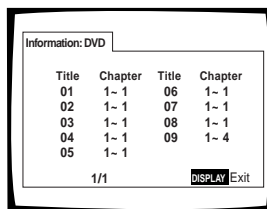

DVD information

When a DVD is loaded, each title and the number of chapters within each title is displayed.

CD and Video CD

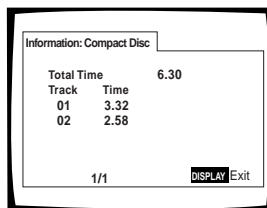

CD and Video CD information

When a CD or Video CD is loaded, the total time of the disc and the time of each track on the disc is displayed.

Changing the Background Color of the Screen Expert

You can select a blue or black background to appear when the player is in the stop mode.

Make changes to the [Background Color] setting in the Setup screen **General** menu in the "Expert" menu mode (page 29).

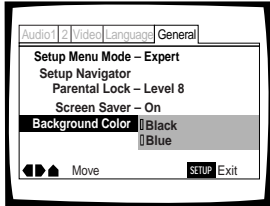

Settings: **Black**
Blue*

*Factory setting

Turning the Screen Saver On and Off Expert

As a protective function against residual images on the TV screen or monitor, a phenomenon referred to as "screen burn", the screen saver appears when the same screen has been displayed for a length of time. By default, the screen saver is turned on. However, the screen saver function can be turned on and off at your discretion.

Make changes to the [Screen Saver] setting in the Setup screen **General** menu in the "Expert" menu mode (page 29).

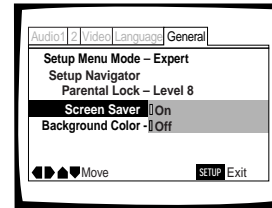

Settings: **On**
Off*

*Factory setting

Resetting the Player to System Settings

To reset the player, press and hold **■ (stop)** on the front panel when pressing **⏻ STANDBY/ON** to turn the unit from standby to on.

All program memory, saved settings from functions such as Last Memory and Condition Memory are cleared, and all Setup screen menus are returned to factory settings.

Additional Information

Disc Care

HOW TO HOLD DISCS

When loading or removing discs, try not to touch their playing surfaces.



CLEANING

Fingerprints or other dirt on the disc may affect sound and picture quality.

To clean your discs, use a soft clean cloth to wipe them. If necessary, moisten a soft cloth with diluted neutral detergent to remove heavy dirt or fingerprints.



Do not wipe in a circular direction (Concentric scratches in the disc groove tend to cause noise.)

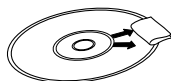

Gently wipe from the inside toward the outer edge.

Discs must not be cleaned with record cleaning sprays, or static prevention sprays, etc. Also do not use volatile liquids such as benzine, or thinner, etc.

LENS CLEANER

The player's pickup lens should not become dirty in normal use, but if for some reason it should malfunction due to soiling, contact your nearest PIONEER authorized service center. Lens cleaners are commercially available, but special care should be exercised in their use since some may cause damage to the lens.

NEVER PLAY CRACKED OR WARPED DISCS

The disc revolves in the player at high speed when it is played. Never play a cracked, scratched or warped disc. This may damage the player or cause it to malfunction.

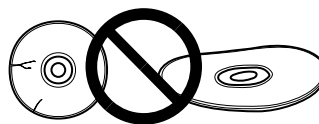

NEVER USE DISCS WITH SPECIAL SHAPES

CD's with special shapes (heart-shaped CDs, octagonal CDs, etc.) cannot be played on this set.

Attempting to do so may damage the set. Do not use such CDs.



AFTER USING DISCS, STORE THEM UPRIGHT

After playing a disc, always remove it from the player and return it to its jacket. Then store it standing upright away from heat and humidity.

- Store discs carefully. If you store discs at an angle, or stacked on top of each other, discs may become warped even when in their jackets.
- Do not leave discs in locations such as the seat of a car, which may become excessively hot.

CAUTION WHEN USING THE DISC

All rights reserved.

Unauthorized public performance, broadcasting or copying is a violation of applicable laws.

Notes on using optical cables

- Do not route cords around sharp angles. When storing, wind the cords so that they have a diameter of at least 15 cm.
- When connecting, push all the way into the terminal.
- Do not use cords with a length of over 3 m.
- If moisture or dust has collected on the plug, wipe it with a soft cloth before connecting.

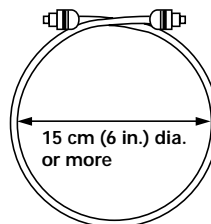

For Proper and Long Use of This Unit

DO NOT MOVE THE UNIT DURING PLAYBACK

During playback, the disc rotates at high speed. Do NOT lift or move the unit during playback. Doing so may damage the disc.

WHEN MOVING THE UNIT

When changing places of installation or packing the unit for moving, be sure to remove the disc and return the disc table to its original position in the player. Then, press **STANDBY/ON** and switch the power to standby. **Check that the “-OFF-” indication on the display goes off**, then disconnect the power cord. Moving this unit with the disc loaded may result in damage to this unit.

INSTALLATION

- Select a stable place to the side of a TV set or stereo system to be connected to the unit.
- When using the unit with a stereo system, install the speakers a little bit away from the TV.
- Do NOT install the unit on top of a TV or color monitor. Install the unit away from equipment that may be affected by magnetism, such as a cassette deck.
- Do NOT place objects on top of the unit.

AVOID INSTALLING IN A PLACE THAT IS:

- Exposed to direct sunlight
- Exposed to humidity or where ventilation is poor
- Extremely hot or cold
- Exposed to vibration
- Exposed to dust
- Exposed to oily smoke, steam or heat (for example, a kitchen)

DO NOT BLOCK VENTS

Do NOT use the player on top of a long-fibered carpet, bed or sofa, and do not cover it with a cloth, etc. This will prevent heat radiation and could result in damage.

AVOID HEAT

Do NOT place the unit on equipment which generates heat, such as an amplifier.

When installing the unit in a rack, place it on the lowest shelf possible (however, not where it is exposed to dust) and separated from the amplifier to avoid the heat generated by the amplifier or other audio equipment.

CAUTION: WHEN PLACING THE UNIT IN A STEREO RACK WITH GLASS DOORS

Be sure there is ample space between the unit and the glass doors when opening the disc table using the remote control. If the disc table opens against strong resistance, such as a closed glass door, damage to the unit may result.

CONDENSATION

Moisture may form in the operating section of the player if the player is brought from cool surroundings into a warm room or if the temperature of the room rises suddenly. When this happens, the player's performance will be impaired.

To prevent this, let the player stand in its new surroundings for about an hour before switching it on, or make sure that the room temperature rises gradually.

Condensation may also form during the summer if the player is exposed to the breeze from an air conditioner. In such cases, change the location of the player.

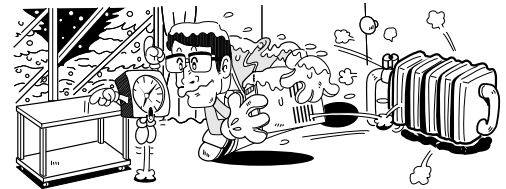

SWITCH POWER OFF WHEN NOT USING THE UNIT

Depending on the strength of the TV or radio broadcast signal, having the TV or radio on while power to the unit is on may result in stripes on the TV screen or noise. However, this is not a malfunction of this unit or the TV or radio. In such a case, switch the power of the unit to standby.

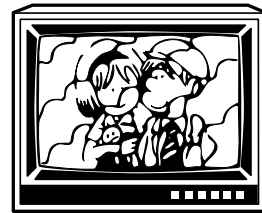

POWER-CORD CAUTION

Handle the power cord by the plug. Do not pull out the plug by tugging the cord and never touch the power cord when your hands are wet as this could cause a short circuit or electric shock. Do not place the unit, a piece of furniture, etc., on the power cord, or pinch the cord. Never make a knot in the cord or tie it with other cords. The power cords should be routed in such a way that they are not likely to be stepped on. A damaged power cord can cause a fire or give you an electrical shock. Check the power cord once in a while. When you find it damaged, ask your nearest PIONEER authorized service center or your dealer for a replacement.

Language Code List

Language codes are used when setting the audio and subtitle language preferences. (See page 38)

Language	Input-code
Japanese (ja)	1001
English (en)	0514
French (fr)	0618
German (de)	0405
Italian (it)	0920
Spanish (es)	0519
Dutch (nl)	1412
Russian (ru)	1821
Chinese (zh)	2608
Korean (ko)	1115
Greek (el)	0512
Afar (aa)	0101
Abkhazian (ab)	0102
Afrikaans (af)	0106
Amharic (am)	0113
Arabic (ar)	0118
Assamese (as)	0119
Aymara (ay)	0125
Azerbaijani (az)	0126
Bashkir (ba)	0201
Byelorussian (be)	0205
Bulgarian (bg)	0207
Bihari (bh)	0208
Bislama (bi)	0209
Bengali (bn)	0214
Tibetan (bo)	0215
Breton (br)	0218
Catalan (ca)	0301
Corsican (co)	0315
Czech (cs)	0319
Welsh (cy)	0325
Danish (da)	0401
Bhutani (dz)	0426
Esperanto (eo)	0515
Estonian (et)	0520
Basque (eu)	0521
Persian (fa)	0601
Finnish (fi)	0609
Fiji (fj)	0610
Faroese (fo)	0615
Frisian (fy)	0625
Irish (ga)	0701
Scots-Gaelic (gd)	0704
Galician (gl)	0712
Guarani (gn)	0714
Gujarati (gu)	0721
Hausa (ha)	0801

Language	Input-code
Hindi (hi)	0809
Croatian (hr)	0818
Hungarian (hu)	0821
Armenian (hy)	0825
Interlingua (ia)	0901
Interlingue (ie)	0905
Inupiak (ik)	0911
Indonesian (in)	0914
Icelandic (is)	0919
Hebrew (iw)	0923
Yiddish (ji)	1009
Javanese (jw)	1023
Georgian (ka)	1101
Kazakh (kk)	1111
Greenlandic (kl)	1112
Cambodian (km)	1113
Kannada (kn)	1114
Kashmiri (ks)	1119
Kurdish (ku)	1121
Kirghiz (ky)	1125
Latin (la)	1201
Lingala (ln)	1214
Laothian (lo)	1215
Lithuanian (lt)	1220
Latvian (lv)	1222
Malagasy (mg)	1307
Maori (mi)	1309
Macedonian (mk)	1311
Malayalam (ml)	1312
Mongolian (mn)	1314
Moldavian (mo)	1315
Marathi (mr)	1318
Malay (ms)	1319
Maltese (mt)	1320
Burmese (my)	1325
Nauru (na)	1401
Nepali (ne)	1405
Norwegian (no)	1415
Occitan (oc)	1503
Oromo (om)	1513
Oriya (or)	1518
Panjabi (pa)	1601
Polish (pl)	1612
Pashto, Pushto (ps)	1619
Portuguese (pt)	1620
Quechua (qu)	1721
Rhaeto-Romance (rm)	1813

Language	Input-code
Kirundi (rn)	1814
Romanian (ro)	1815
Kinyarwanda (rw)	1823
Sanskrit (sa)	1901
Sindhi (sd)	1904
Sangho (sg)	1907
Serbo-Croatian (sh)	1908
Singhalese (si)	1909
Slovak (sk)	1911
Slovenian (sl)	1912
Samoaan (sm)	1913
Shona (sn)	1914
Somali (so)	1915
Albanian (sq)	1917
Serbian (sr)	1918
Siswati (ss)	1919
Sesotho (st)	1920
Sundanese (su)	1921
Swedish (sv)	1922
Swahili (sw)	1923
Tamil (ta)	2001
Telugu (te)	2005
Tajik (tg)	2007
Thai (th)	2008
Tigrinya (ti)	2009
Turkmen (tk)	2011
Tagalog (tl)	2012
Setswana (tn)	2014
Tonga (to)	2015
Turkish (tr)	2018
Tsonga (ts)	2019
Tatar (tt)	2020
Twi (tw)	2023
Ukrainian (uk)	2111
Urdu (ur)	2118
Uzbek (uz)	2126
Vietnamese (vi)	2209
Volapük (vo)	2215
Wolof (wo)	2315
Xhosa (xh)	2408
Yoruba (yo)	2515
Zulu (zu)	2621

Troubleshooting

Incorrect operations are often mistaken for trouble and malfunctions. If you think that there is something wrong with this component, check the points below. Sometimes the trouble may lie in another component. Inspect the other components and electrical appliances being used. If the trouble cannot be rectified even after exercising the checks listed below, ask your nearest PIONEER authorized service center or your dealer to carry out repair work.

The disc table comes back out automatically, shortly after the disc table is closed.

The disc is dirty or warped.

- ➔ Refer to "Disc Care" (page 55).

The disc is not placed properly on the disc table.

- ➔ Use the disc table guide to align the disc (page 24).

Region number does not conform with this unit.

- ➔ If the region number on the disc does not match the number on the player, the disc cannot be used (page 61).

There is condensation on the operating section of the player.

- ➔ Allow time for condensation to evaporate. If player is near an air conditioning unit, you should move the player (page 56).

Playback is not possible.

The disc has been loaded upside down.

- ➔ Check that the disc has been loaded with the label side facing up.

mark appears on screen.

The selected function does not operate for that disc.

mark appears on screen.

The operation is prohibited by the player.

Picture playback stops and the operation buttons cannot be used.

Player malfunctions.

- ➔ Stop disc playback (press **STOP** ■), then start playback again.

New settings made in the Setup screen menus while a disc is playing are ineffective.

Some settings can be changed while a disc is playing, but are not effective. This is not a malfunction.

- ➔ Make the same setting when the player is stopped.
- ➔ Stop disc playback (press **STOP** ■), then start playback again. When playback is resumed, the new settings should be in effect. Please note that making settings in the Setup screen menus may cancel the resume function.

When making changes in the Setup screen menus, is displayed.

There is a CD loaded in the player and the setting that was changed only applies to DVD performance.

- ➔ The settings will be effective the next time a DVD is loaded.

Settings are canceled.

When the power is turned off by power failure or by unplugging the power cord, settings will be canceled.

- ➔ Before unplugging the power cord, press  **STANDBY/ON** and check that "--OFF--" disappears in the display.

No picture.

The rear panel's VIDEO OUT SELECT switch setting is not correct.

- ➔ Check that the VIDEO OUT SELECT switch is set to the correct position for the monitor connection you are using (page 19).

Connection is incorrect.

- ➔ Check that cord connections are correct and that plugs are firmly connected.

Operation (settings) of TV or AV amplifier is not appropriate.

- ➔ Be sure that your TV, receiver, or amplifier is set up to view DVD playback.

The screen is stretched or aspect does not change.

The multi aspect setting is not appropriate.

- ➔ Change the aspect setting in the [TV Screen] setting in the Setup screen **Video** menu to the screen type most appropriate to the TV or monitor you are using (page 33).

Picture disturbance during playback or dark.

This is not a malfunction.

- ➔ This player is compatible with Macro-Vision System copy guard. Some discs include a copy prevention signal, and when this type of disc is played back, stripes etc., may appear on some sections of the picture depending on the TV.

When recorded on a VCR or passed through an AV selector, there is disturbance in the playback picture.

This is not a malfunction.

- ➔ Due to the player's copy protection circuits, connection of this device through a VCR or an AV selector may prevent recording or cause picture problems.

Remote control operation is not possible.

The rear panel control input jack on the player is being used.

- ➔ Point the remote control at the component that the player is connected to (page 19).

The remote control is too far from the player, or the angle with the remote sensor is too wide.

- ➔ Be sure to operate the remote from a location within its operating range (page 8).

The batteries are exhausted.

- ➔ Replace the exhausted batteries with all new batteries (page 8).

Audio is not output or is distorted.

The Setup screen **Audio 1** menu [96kHz PCM Out] setting is set to "96 kHz". Digital output is prohibited on some discs.

- ➔ Be sure to make analog audio connections as well as digital connections (pages 17 and 18).

The disc is dirty.

- ➔ Refer to "Disc Care" (page 55).

The connection plugs are not inserted fully into the terminals or are not connected.

- ➔ Check that all connection plugs are firmly inserted.

The connection plug or terminal is dirty.

- ➔ Check that the plugs and terminals are wiped clean of dirt, etc.

Audio cable connection is wrong.

- ➔ Check to make sure that the audio cables are connected correctly (pages 17 and 18).

Connection is made to the stereo amplifier's PHONO input terminal.

- ➔ Change connection to any input terminal except PHONO.

The pause mode is engaged.

- ➔ Press **PLAY ►** or **II** to exit the pause mode.

Stereo amplifier operation is incorrect.

- ➔ Check input (CD, AUX, etc.) selector to determine if it is selected for DVD playback.

The DVD is recorded in DTS audio.

- ➔ DTS audio is only output from the digital output jacks. Connect the digital output on the player to the digital input on a receiver or amplifier with a built in DTS decoder to hear DTS audio.

Noticeable difference in DVD and CD volume.

DVDs and CDs use different recording methods.

- ➔ This is not a malfunction.

Audio mix does not sound right or sounds incomplete (for example, the dialog of the actors cannot be heard).

Audio output selection is incorrect.

- ➔ When 5.1 channel audio output is selected, the front right (R) and left (L) audio channels are output from the 2 channels jacks. Similarly, when 2 channel audio output is selected, the stereo channels are output from the front right (R) and left (L) audio channels of the 5.1channel jacks. Check that the correct output is selected (page 31).

Caution

Static electricity or other external influence may cause malfunctioning of this unit. In this case, unplugging the power cord and then re-plugging it in will usually reset the unit for proper operation. If this does not correct the problem, please consult your nearest PIONEER service center.

Terms

Aspect ratio

Aspect ratio refers to the length to height ratio of TV screens. The ratio of a standard TV is 4:3, while the ratio of a high-definition or wide TV is 16:9. The latter allows you to enjoy a picture with a wider perspective.

Chapter number

Chapter numbers are the numbers assigned to sections of a title on the disc, similar to chapters in a book. If the disc includes chapter numbers, you can locate the section you want very quickly using search and other functions.

Component (color difference) video output

The color signal of the TV is divided into the luminance (Y) signal and the color (P_B and P_R) signals and then output. In this way mutual interference of each signal is avoided. On a TV with component input jacks, these signals are synthesized to produce the picture.

Condition memory

“Condition” refers to the various mode settings, etc. On this player, various conditions, such as those set during playback, can be memorized. This function allows you to play back the same disc at any time without having to redo your preferred settings.

Digital bitstream

The bitstream does not refer to the audio signal, but rather to the digital data that, once converted, becomes the audio signal. The player outputs digital bitstreams via the digital optical or digital coaxial output. If the bitstream cannot be decoded by the connected AV amplifier etc., digital noise is produced. Digital bitstream formats compatible with different entertainment systems can be selected in the Setup screen **Audio 1** menu.

Digital output (Coaxial)

Output of the digital audio signal is transmitted electronically using a coaxial cable. Because the signal being transmitted is digital, connection must be made to the coaxial digital input of another component. Noise will be output if connected to the analog audio inputs as the digital signal cannot be decoded.

Digital output (Optical)

Normally, audio is converted to an electric signal and transmitted through an electric wire from the player to the amplifier, etc. Changing this signal to a digital signal and transmitting it through an fiber-optic cable is called optical digital output. Similarly, optical digital input receives digital signals from external units such as an AV amplifier or receiver.

Dolby Digital

The maximum 5.1 channels of audio used in the surround system (Surround Digital) for movie theaters is digital data compressed by the third generation algorithm encoder, AC-3.



DTS

DTS stands for Digital Theater System. DTS is a surround system different from Dolby Digital that has become a popular surround sound format for movies. In order to enjoy the benefits of DTS encoded discs, the digital output jack (either coaxial or optical) of this player needs to be connected to an AV amplifier or receiver with DTS decoding capability or to a DTS decoder. DTS audio is not output from the analog audio outputs.

Dynamic range

Dynamic range refers to the difference between the maximum and minimum levels of the audio soundtrack as measured in decibels (dB).

Compressing the dynamic range raises the minimum signal level and lowers the maximum signal level. This allows you to hear voices and other low level audio signals clearly while lowering strong audio signals like the sound of explosions.

MPEG

Short for Moving Picture Experts Group. This is an international standard for compression of moving images. On some DVDs, digital audio has been compressed and recorded in this format.

Multi-angle

When you watch a TV program, you are watching the image filmed through the TV camera. Because of this, the picture is displayed on your TV from the viewpoint of the TV camera's position. In a TV studio, the image is filmed by many cameras at the same time, and one of those images is selected by the program director and transmitted to your TV. If all the filmed images were transmitted to your TV you would be able to select the camera image you want. Some DVD discs are recorded with the angles of more than one camera used for filming, and these can be selected using this player. These types of discs are called multi-angle discs.

Parental lock level

This function was suggested by parents concerned about what type of media their children were able to watch. Parental lock restrictions are restrictions incorporated into titles which include scenes that parents may not wish their children to view.

PCM

PCM stands for Pulse Code Modulation and is digital audio. The digital audio of CDs is PCM. This player also has a function that converts Dolby Digital and MPEG digital bitstreams into PCM to enable you to listen to quality digital sound even without a special decoder.

Playback Control (PBC)

This refers to signals recorded on a Video CD (Version 2.0) enabling playback control.

You can use menus recorded on discs with PBC for easy, interactive search for desired scenes, and playback.

You can also enjoy viewing high-resolution/standard resolution still images.

Regional restriction codes (region number)

Regional restriction codes are built in to DVD players and DVD discs for each sales region. If the regional code of the DVD player does not match one of the regional codes of the DVD disc, playback is not possible.

The region number can be found on the rear panel of the DVD player. The illustration below shows the regions and corresponding region numbers.

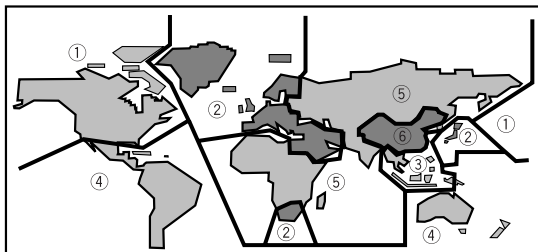

Sampling Frequency

When a sound wave is converted to a digital signal, the sound is sampled and converted to data at a specific frequency rate. For example, a signal with a 96 kHz sampling rate indicates that in one second, the analog signal was sampled 96000 times to produce the digital signal.

Subtitle

Subtitles are language titles superimposed on movies, or other media. Up to 32 different subtitle languages can be recorded on a DVD disc. The subtitle function can be used to select the language of your choice.

S-video

Connecting the S-video output on the player to a TV or monitor with S-video input via an S-video cable produces clearer picture reproduction by sending separate signals for the luminance and the color. These signals are then combined by the television to produce a better quality picture.

System control

When you connect this player via a cord with a mini plug to another Pioneer component such as a receiver or an amplifier bearing the  mark, you can control the player as though it were a component in a system. To control the player, point the player's remote control at the component that the player is connected to, and not the player itself.

Time number

The time number corresponds to the elapsed playback time of a disc from its beginning. When using the time search function, use the time number to locate scenes that occur at the time selected.

Title number

DVD discs are divided into units referred to as titles, and titles are divided into chapters. Menu screens do not belong to any title. A disc which contains a movie may have only one title with many or no chapter divisions. Karaoke discs may have many titles, assigning a title to each song on the disc.

Specifications

General

System ... DVD system and Compact Disc digital audio system
Power requirements AC 120 V, 60 Hz
Power consumption 14 W
Power consumption in standby mode 0.7 W
Weight 4.5 kg (9 lb 9 oz)
Dimensions 420 (W) x 376 (D) x 128 (H) mm
(16 ⁹/₁₆ (W) x 14 ¹³/₁₆ (D) x 5 ¹/₁₆ (H) in.)
(Not including protruding cables, etc.)
Operating temperature +5°C to +35°C (+36°F to +96°F)
Operating humidity 5% to 85% (no condensation)

S-Video output

Y (luminance) - Output level 1 Vp-p (75 Ω)
C (color) - Output level 286 mVp-p (75 Ω)
Jack S-VIDEO jack

Video output

Output level 1 Vp-p (75 Ω)
Jack RCA jack

Component video output

(Y, P_B, P_R)
Output level Y: 1.0 Vp-p (75 Ω)
P_B, P_R: 0.7 Vp-p (75 Ω)
Jacks RCA jacks

Audio output (2 CH)

Output level
During audio output 200 mVrms (1 kHz, -20 dB)
Number of channels 2
Jacks RCA jacks

Audio output (5.1 CH)

Output level
During audio output 200 mVrms (1 kHz, -20 dB)
Number of channels 6
Jacks RCA jacks

Digital audio characteristics

Frequency response 4 Hz to 44 kHz (DVD fs: 96 kHz)
S/N ratio 115 dB
Dynamic range 103 dB
Total harmonic distortion 0.002%
Wow and flutter Limit of measurement
(±0.001% W. PEAK) or lower

Digital output

Optical digital output Optical digital jack
Coaxial digital output RCA jack

Other terminals

CONTROL IN Minijack (3.5 ø)

Accessories

Remote control unit 1
AA (R6P) dry cell batteries 2
Audio cord 1
Video cord 1
Power cord 1
Operating Instructions 1

Note

The specifications and design of this product are subject to change without notice, due to improvement.

Should this product require service in the U.S.A. and you wish to locate the nearest Pioneer Authorized Independent Service Company, or if you wish to purchase replacement parts, operating instructions, service manuals, or accessories, please call the number shown below.

8 0 0 – 4 2 1 – 1 4 0 4

Please do not ship your product to Pioneer without first calling the Customer Service Department at the above listed number for assistance.

PIONEER ELECTRONICS SERVICE, INC.
CUSTOMER SERVICE DEPARTMENT
P.O. BOX 1760, LONG BEACH,
CA 90801-1760, U.S.A.

For warranty information please see the Limited Warranty sheet included with your product.

Should this product require service in Canada, please contact a Pioneer Canadian Authorized Dealer to locate the nearest Pioneer Authorized Service Company in Canada.

Alternatively, please contact the Customer Service Department at the following address:

Pioneer Electronics of Canada, Inc.
Customer Service Department
300 Allstate Parkway, Markham, Ontario L3R OP2
(905) 479-4411
1-877-283-5901

For warranty information please see the Limited Warranty sheet included with your product.

Si ce produit doit être réparé au Canada, veuillez vous adresser à un distributeur autorisée Pioneer au Canada pour obtenir le nom de la Société de Service Autorisée Pioneer le plus près de chez vous. Ou encore, veuillez vous communiquer avec le Service de Clientèle de Pioneer:

Pioneer électroniques du Canada, Inc.
Département de service au consommateurs
300 Allstate Parkway, Markham, Ontario L3R OP2
(905) 479-4411
1-877-283-5901

Pour obtenir des renseignements sur la garantie, veuillez vous reporter au feuillet sur la Garantie Limitée qui accompagne le produit.

When moving the player

Be sure to follow the necessary steps and precautions whenever moving or transporting the player (page 56).



We Want You Listening For A Lifetime

Dear Customer:

Selecting fine audio equipment such as the unit you've just purchased is only the start of your musical enjoyment. Now it's time to consider how you can maximize the fun and excitement your equipment offers. This manufacturer and the Electronic Industries Association's Consumer Electronics Group want you to get the most out of your equipment by playing it at a safe level. One that lets the sound come through loud and clear without annoying blaring or distortion-and, most importantly, without affecting your sensitive hearing.

Sound can be deceiving. Over time your hearing "comfort level" adapts to higher volumes of sound. So what sounds "normal" can actually be loud and harmful to your hearing. Guard against this by setting your equipment at a safe level BEFORE your hearing adapts.

To establish a safe level:

- Start your volume control at a low setting.
- Slowly increase the sound until you can hear it comfortably and clearly, and without distortion.

Once you have established a comfortable sound level:

- Set the dial and leave it there.

Taking a minute to do this now will help to prevent hearing damage or loss in the future. After all, we want you listening for a lifetime.

Used wisely, your new sound equipment will provide a lifetime of fun and enjoyment. Since hearing damage from loud noise is often undetectable until it is too late, this manufacturer and the Electronic Industries Association's Consumer Electronics Group recommend you avoid prolonged exposure to excessive noise. This list of sound levels is included for your protection.

Decibel

Level	Example
30	Quiet library, soft whispers
40	Living room, refrigerator, bedroom away from traffic
50	Light traffic, normal conversation, quiet office
60	Air conditioner at 20 feet, sewing machine
70	Vacuum cleaner, hair dryer, noisy restaurant
80	Average city traffic, garbage disposals, alarm clock at two feet.

THE FOLLOWING NOISES CAN BE DANGEROUS UNDER CONSTANT EXPOSURE

90	Subway, motorcycle, truck traffic, lawn mower
100	Garbage truck, chain saw, pneumatic drill
120	Rock band concert in front of speakers, thunderclap
140	Gunshot blast, jet plane
180	Rocket launching pad

Information courtesy of the Deafness Research Foundation.



Published by Pioneer Corporation.
Copyright © 1999 Pioneer Corporation.
All rights reserved.

PIONEER CORPORATION 4-1, Meguro 1-Chome, Meguro-ku, Tokyo 153-8654, Japan
PIONEER ELECTRONICS [USA] INC. P.O. BOX 1540, Long Beach, California 90801-1540, U.S.A.
PIONEER ELECTRONICS OF CANADA, INC. 300 Allstate Parkway, Markham, Ontario L3R 0P2, Canada
PIONEER ELECTRONIC [EUROPE] N.V. Haven 1087, Keetberglaan 1, 9120 Melsele, Belgium TEL: 03/570.05.11
PIONEER ELECTRONICS AUSTRALIA PTY. LTD. 178-184 Boundary Road, Braeside, Victoria 3195, Australia, TEL: [03] 9586-6300
PIONEER ELECTRONICS DE MEXICO S.A. DE C.V. San Lorenzo Num 1009 3er piso Desp. 302 Col. Del Valle, Mexico D.F. C.P. 03100
TEL: 5-688-52-90